



**Version :** 2.1 (for firmware 1.11 or higher)

**Date :** Oct 2021

**Éditeur :** Waves System

**Auteur(s) :** Thierry Roger

# Licence



Waves System products are exclusively manufactured by Waves System

14, rue Philippe Lebon- 44980 Sainte Luce Sur Loire- FRANCE

Sales and informations : +33 (0)2 40 78 22 44

E-mail : [sales@wssystem.com](mailto:sales@wssystem.com)

Website : <https://waves-system.com>

# Table des matières

Welcome .....	6
1. Safety instructions .....	7
2. Content of the box .....	10
3. Description of the player .....	13
3.1. Input contacts .....	15
3.2. Output contacts .....	18
4. Startup and configuration .....	21
5. Connexion diagram .....	22
6. Set up and update your content media support .....	23
6.1. First setup of removable content support .....	23
6.2. Update content on removable content support .....	23
6.3. Update content directly from your local network .....	23
7. First steps with your player VP330 .....	24
7.1. Autoplay .....	24
7.2. Using input contacts of your player VP330 .....	24
7.3. Identify the player on your local network .....	25
8. Control the player with folders and files .....	26
8.1. Arrangement of folders .....	26
8.2. Add tags to the name of folders to build your scenario .....	28
8.2.1. [Jxxx] - Jump to folder xxx at the end of the playback of the folder .....	29
8.2.2. [LOOP] - Play the folder in loop without the tags at each loop. .....	29
8.2.3. [RESUME] - Save the reading position of the files when returning to the folder .....	29
8.2.4. [RET] - Return to the previous folder at the end of the playback of the folder .....	30
8.2.5. [RND] or [SEQ] - Sequential or random playback mode .....	30
8.2.6. [Vx] - Adjust the absolute volume of the folder .....	30
8.2.7. [V+x] ou [V-x] - Relative volume of the folder .....	31
8.2.8. [NT] - Disable the command events during the playback of the folder .....	31
8.2.9. [NRST] or [NORESTART] - Disable retriggering of a folder when being played .....	32
8.2.10. [WHL] - Play the folder while the assigned input combination remains activated .....	32
8.2.11. [NXTxxx] - Play the next xxx media files each time the folder is played .....	32
8.2.12. [SUBS x] and [SUBE x] - Define the settings to display subtitles at the beginning or at the end of the playback .....	33
8.2.13. [WEBS x] and [WEBE x] - Open a webpage at the beginning or at the end of the folder playback .....	33
8.2.14. [WEBS OFF] and [WEBE OFF] - Close a webpage at the beginning or at the end of the folder playback .....	33
8.2.15. [PROJS ON], [PROJE ON], [PROJS OFF] and [PROJE OFF] .....	34
8.2.16. [RESxxxxxxx] and [REExxxxxxx] - Activate or deactivate output contacts .....	34
8.2.17. [RSSxxx] or [RSExxx] - Send bytes through the RS-232 output .....	34
8.2.18. Description of folder SYSTEM (optional) .....	36
8.2.19. Description of folder WWW (optional) .....	36
8.3. Arrangement of files inside folders .....	36
8.4. Add tags to the name of files to build your scenario .....	37
8.4.1. [Jxxx] - Jump to folder xxx at the end of the playback of the file .....	37
8.4.2. [NT]: Disable the command events during the playback of the file .....	38
8.4.3. [DUR x] or [DURATION x] - Define the duration of playback of a picture .....	38
8.4.4. [SUBS x] and [SUBE x] - Define the settings to display subtitles at the beginning or at the end of the playback .....	38

8.4.5. [SYNCHRO] - Synchronize players to start playback simultaneously	39
8.4.6. [WEBS x] and [WEBE x] - Open a webpage at the beginning or at the end of the file playback	39
8.4.7. [WEBS OFF] and [WEBE OFF] - Close a webpage at the beginning or at the end of the file playback	39
8.4.8. [PROJS ON], [PROJE ON], [PROJS OFF] and [PROJE OFF]	39
<b>8.5. Adding subtitles to videos</b>	<b>39</b>
8.5.1. Naming subtitles in separated files	40
8.5.2. Encapsulated subtitles	40
8.5.3. Select one subtitle on the fly	40
<b>8.6. Playback a slideshow</b>	<b>40</b>
<b>8.7. Playback of audio files</b>	<b>40</b>
<b>8.8. Modification of background image when player is in state "STOP"</b>	<b>40</b>
<b>8.9. Using RS-232 serial link</b>	<b>41</b>
<b>8.10. Using TCP/IP link</b>	<b>41</b>
<b>9. Synchronize players to start playback simultaneously</b> .....	<b>42</b>
<b>10. Control the player with a scheduler</b> .....	<b>44</b>
10.1. Introduction	44
10.2. Principle	44
<b>11. Control the player using the HTML5 engine</b> .....	<b>46</b>
<b>12. Settings on front panel</b> .....	<b>47</b>
12.1. Volume knob	47
<b>13. Infrared remote control</b> .....	<b>48</b>
<b>14. Advanced configuration</b> .....	<b>49</b>
14.1. System info	49
14.2. System settings	49
14.2.1. Playback engine	49
14.2.2. Log	49
14.2.3. Network	50
14.2.3.1. IP settings	50
14.2.4. Display	50
14.2.4.1. Resolution	50
14.2.4.2. Display aspect	50
14.2.4.3. Dynamic range	50
14.2.4.4. Custom video display area	50
14.2.5. HDMI CEC	50
14.2.6. Video projector	50
14.2.7. Sound	51
14.2.8. Subtitles	51
14.2.9. Serial port	51
14.2.10. Input contacts	51
14.2.11. Printer	51
14.2.12. FTP server	51
14.2.13. Web browser	52
14.2.14. Date and time	52
14.2.15. Language	52
14.2.16. Device identification	52
14.2.17. Boot sequence	52
14.2.18. System update	52
<b>14.3. Scenario settings</b>	<b>52</b>

14.3.1. Startup volume	52
14.3.2. Autoplay folder	52
14.3.3. Sources blocked by [NT]	53
14.3.4. Input contacts	53
14.3.5. Remote control	53
14.3.6. Playback start synchronisation	53
14.3.7. Volume notifications	53
14.3.8. Websites	53
<b>14.4. System control</b>	<b>53</b>
14.4.1. Video playback	53
14.4.2. Power state	54
14.4.3. Neighborhood	54
14.4.4. Console	54
14.4.5. File manager	54
<b>15. RS-232 &amp; TCP/IP communication protocol .....</b>	<b>55</b>
15.1. Player control commands	56
15.1.1. Jump to a folder	56
15.1.2. Play and standby	57
15.1.3. Set the volume	59
15.1.4. Request information	59
15.2. Update the clock	61
15.2.1. Update the local time	61
15.2.2. Update the local date	61
15.2.3. Update the local date and time	61
15.2.4. Update the UTC/GMT date and time (epoch version)	62
15.2.5. Update the UTC/GMT date and time (complete version)	62
15.2.6. NTP activation/deactivation	63
15.3. Command to select subtitles	64
15.3.1. Generic command to select subtitles	64
15.3.2. Select a subtitle track with language code	64
15.3.3. Select a subtitle track using track index	65
15.3.4. List all subtitle tracks	65
15.4. Unitary transmission mode and daisy chain	65

# Welcome

My Video Player VP330 is a media player designed to broadcast 4k video, images, music, web pages and audio. Files are stored in a USB stick or  $\mu$ SD/SDHC card or an internal flash memory (4Go available).



This player can easily read media files in a loop or can be triggered through external events such as entry contact, TCP/IP requests, HTTP requests, schedule ...

The player embeds also 8 GPI, 8 GPO based on Mosfet and one RS232 link.



VP330 is ideal for retails, museums, exhibitions and theme parks.



## ★ Refer to the user guide

- From a web browser: <https://waves-system.com/>.
- From the menu  Documentation utilisateur de la  remote administration of VP330.

## ⚠ Safety

Refer to chapter   Safety instructions <sup>[p.7]</sup> of **VP330** user guide.

# 1. Safety instructions

## Warning

CAUTION! DO NOT EXPOSE THE PRODUCT TO HUMIDITY NOR DUST!

Unplug the power supply cable before any servicing

FOR YOUR SAFETY, PLEASE READ CAREFULLY THE USER'S GUIDE BEFORE OPERATING YOUR PLAYER VP330.

## CE marking

The CE marking is placed on the nameplate, at the rear side of the device. It attests to compliance of the device with low voltage CE directive according to EN 55022 standard, and the Electromagnetic Compatibility Directive 61000-4-x.

## Overview

- The user manual is an integral part of the product. It must always be kept handy & close by. Proper usage involves strict compliance with the instructions given in this manual. In the event of return of the equipment, the user manual should be handed over to the new purchaser. The staff should receive instructions concerning the proper usage of the device.
- Only the use of genuine parts ensures perfect safety for the user and correct operation of the device. Moreover, only accessories mentioned in the technical documentation or explicitly approved by the manufacturer must be used. If accessories or consumable products from other brands are used, the manufacturer cannot stand guarantee for the correct and safe operation of the device.
- Damages caused through the use of accessories or consumable products from other brands will not entail right to any benefit under the terms of warranty.
- The manufacturer will be liable for the safety, reliability and functioning of the product as long as the assembly, settings, modifications, extensions and repairs have been carried out by the manufacturer or a company approved by the manufacturer, and if the device is used in accordance with the instructions mentioned in this manual.
- The player complies with the technical safety standards in force at the date of print of this manual. All rights reserved for the electrical diagrams, procedures, names and devices mentioned herein.
- Any reproduction of the technical documentation, even partially, without the written authorization from Waves System is prohibited.

## General safety instructions

This device has been shipped out from our facilities in perfect working condition. In order to preserve these conditions, for safety and to avoid any risk of accidental bodily injury, the user must imperatively follow the safety instructions and read the 'Caution!' messages included in this manual.

This device, made by Waves System, has been designed in a way that practically eliminates any risk if it







is used in accordance with its intended purpose. Nevertheless, for the sake of safety, we would like to draw your attention to the following instructions:

- When using the device, comply with all local rules and regulations in force. Any modification or conversion of the device automatically entails loss of the certification. The operation of a modified device is liable to a penalty. In the interests of occupational safety, the operator and the user are held responsible for complying with the regulations.
- Keep the original packing for a possible product reshipment. Also ensure that the packing material is kept out of the reach of children. Only this original packing ensures optimal protection for the product during transportation. If a product reshipment appears to be necessary during the guarantee period, Waves System is not liable for any ensuing damages arising during the transportation and attributable to a defective packing.
- This device should be used only by persons whose training or knowledge ensures proper handling.
- Before each use, the operator must check that the device is in perfect working condition.
- This product must not be used in places where there is a potential explosion risk. Besides, it must neither be used in an environment favoring combustion nor in a humid or excessively hot or cold location.
- Maximal temperature of use: +45°C
- Storage temperature: from 0°C up to +60°C

## **Safety instructions against risks due to electric currents**

- The device must be connected to a grounded AC power outlet or a European standard outlet installed as per good professional practices.
- Disconnecting means of primary supply: Power outlet is used as the disconnecting means of primary supply, it shall remain accessible.
- Power supply: 12V DC - 3,45 A
- Before connecting the device, check that the mains voltage and frequency match the specifications indicated on the mains adapter.
- Before powering, check that the device and cables are not damaged. Damaged cables and connections must immediately be replaced.
- Never allow the power cords to come in contact with other cables. Handle the mains adapter cable as well as all other cables connected to the mains with extreme care.
- Always connect the power cord to the device first, then to the mains. The power outlet must remain accessible after the installation.
- Check the device and its mains adapter cable from time to time. Disconnect the device from the mains when it is no longer used or for the purpose of maintenance.
- Handle the power cord by using only the plug. Never remove the plug by pulling the power cord.
- Electrical connections, repairs, and maintenance must be carried out by qualified personnel.
- Do not switch the device on or off within a short period of time as this reduces its lifespan.



	THE LIGHTNING FLASH WITH ARROWHEAD SYMBOL, WITHIN AN EQUILATERAL TRIANGLE, IS INTENDED TO ALERT THE USER TO THE PRESENCE OF UNINSULATED "DANGEROUS VOLTAGE" WITHIN THE PRODUCT'S ENCLOSURE THAT MAY BE OF SUFFICIENT MAGNITUDE TO CONSTITUTE A RISK OF ELECTRIC SHOCK TO PERSONS
	THE EXCLAMATION POINT WITHIN AN EQUILATERAL TRIANGLE IS INTENDED TO ALERT THE USER TO THE PRESENCE OF IMPORTANT OPERATING AND MAINTENANCE (SERVICING) INSTRUCTIONS IN THE LITERATURE ACCOMPANYING THE APPLIANCE. Warning, the user's guide must be red each time the symbol is written.
	Direct current
	WEEE
	User's guide must be red each time this symbol is written.
	Positive electric polarity

## Terms of use

- This product has been designed for indoor use only.
- The device must be attached under 2m high from the ground.
- If this device has been exposed to very high temperature fluctuations (e.g.: after transportation), do not connect it immediately. The condensation formed inside the device could damage it. Allow the device to reach ambient temperature before connecting it.
- Do not shake the device. Avoid sudden movements during its installation or handling.
- When selecting the spot for installation of the player, ensure that it is not exposed to a high source of heat, moisture, or dust. There should not be any cables lying around as they might jeopardize your and others' safety.

## 2. Content of the box

### Box

#### What's inside the box



#### 1 My Video Player



Player VP330.

## 2 Remote control



You can use the remote control to configure the player through the screen or to change the playback.

## 3 Power supply



#### 4 Power cord



The power cord is adapted to the country of destination.

#### 5 Quick start manual

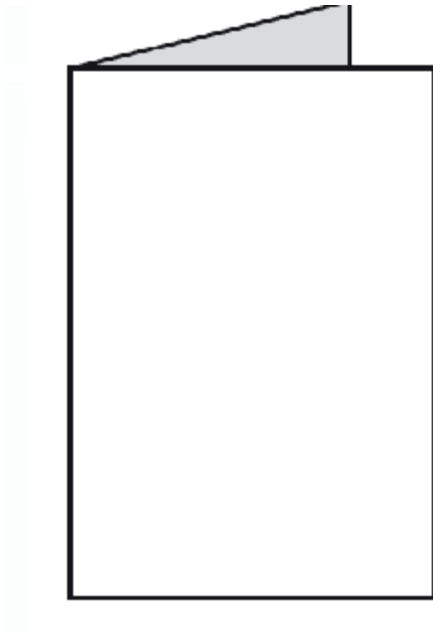

#### 6 Primary batteries



2 primary batteries are supplied with the remote control.

## 3. Description of the player

### Front panel of the player VP330

#### Introduction of player VP330



#### 1 Headphone jack



Plug your headphone to listen to the media from the service room.

#### 2 Infrared sensor for the remote control



Thanks to the remote control, display and browse the configuration menu

#### 3 Volume knob



Adjust the volume through the button.

#### 4 Activity LED



Interaction	Function
green	Steady green: ready, stop Blinking green: ready, reading
red	standby

### Rear panel of the player VP330

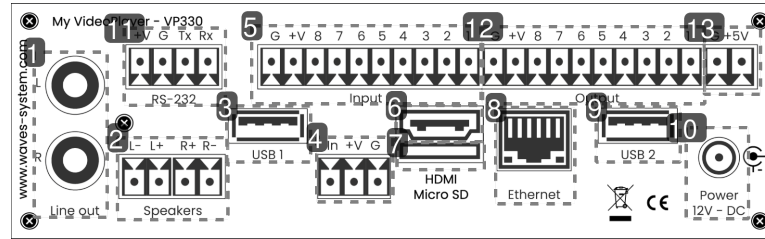

## 1 Analog audio output to connect an amplifier



Line out

## 2 Amplified audio output to connect loudspeakers

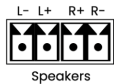

Speakers

## 3 USB 1 port to connect a storage medium or a pointing device



USB 1

## 4 Entry contact coupled with a 12V power supply



## 5 8 entry contacts

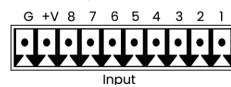

Input

## 6 HDMI audio/video output



## 7 Micro SD



## 8 Ethernet connector 10/100 Mbit/s



Ethernet

## 9 USB 2 port



USB 2

## 10 Power supply



Power  
12V - DC

### 1 1 RS232 serial link

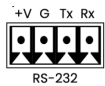

### 1 2 8 Mosfet output

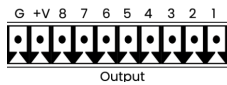

### 1 3 5V power output



## 3.1. Input contacts

The player has 8 input contacts. Input 1 est doubled. Each input. Connect directly each input to a push button or a sensor from Waves System portfolio. An input contact is defined by:

- In : trigger
- +V : 12V output power to power the sensor
- G : Ground

The contact is triggered when In is connected to Ground G.

The 8 input contacts can be extended by one or 2 extension boards (Ext15In). Each board converts 4 inputs into 15 inputs.

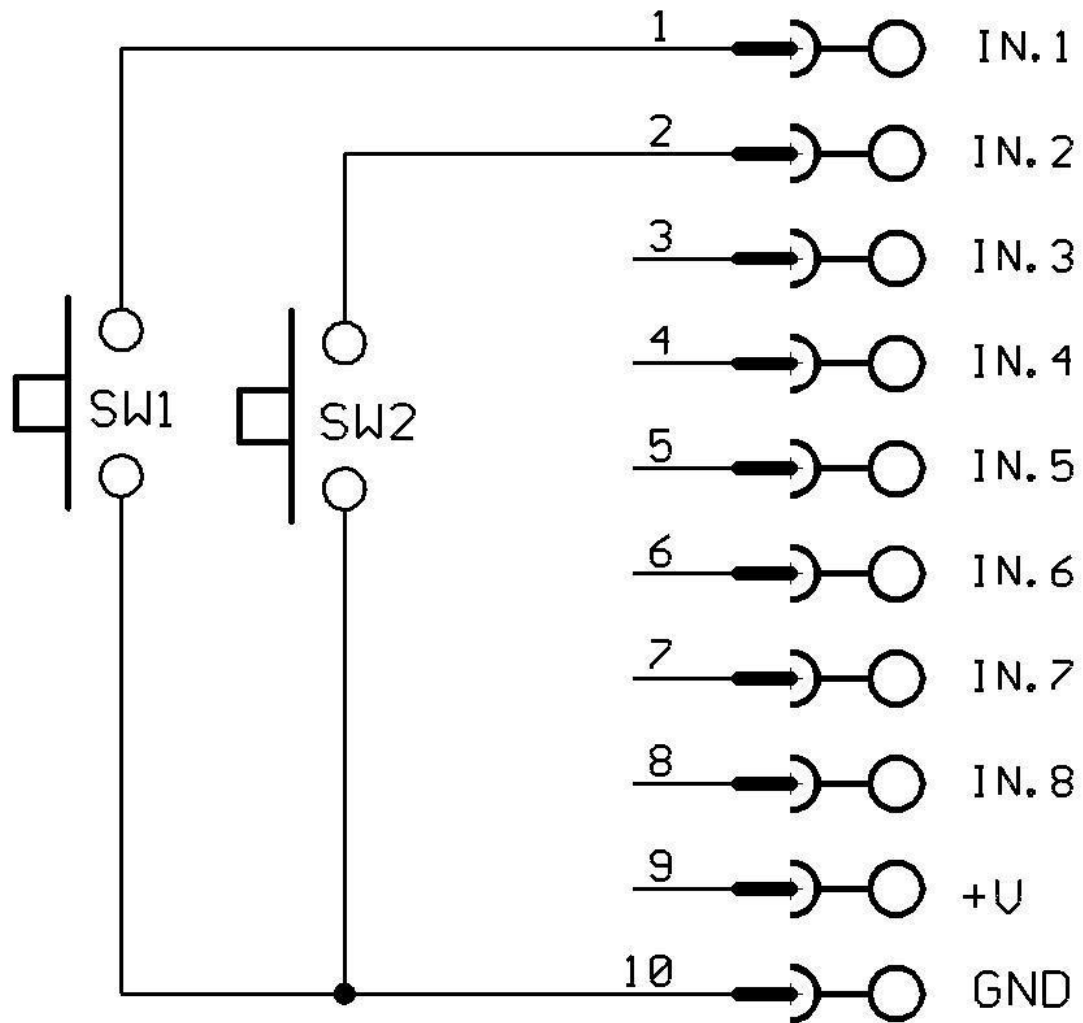

Play folder001 with push button SW1. Play folder 002 with push button SW2.



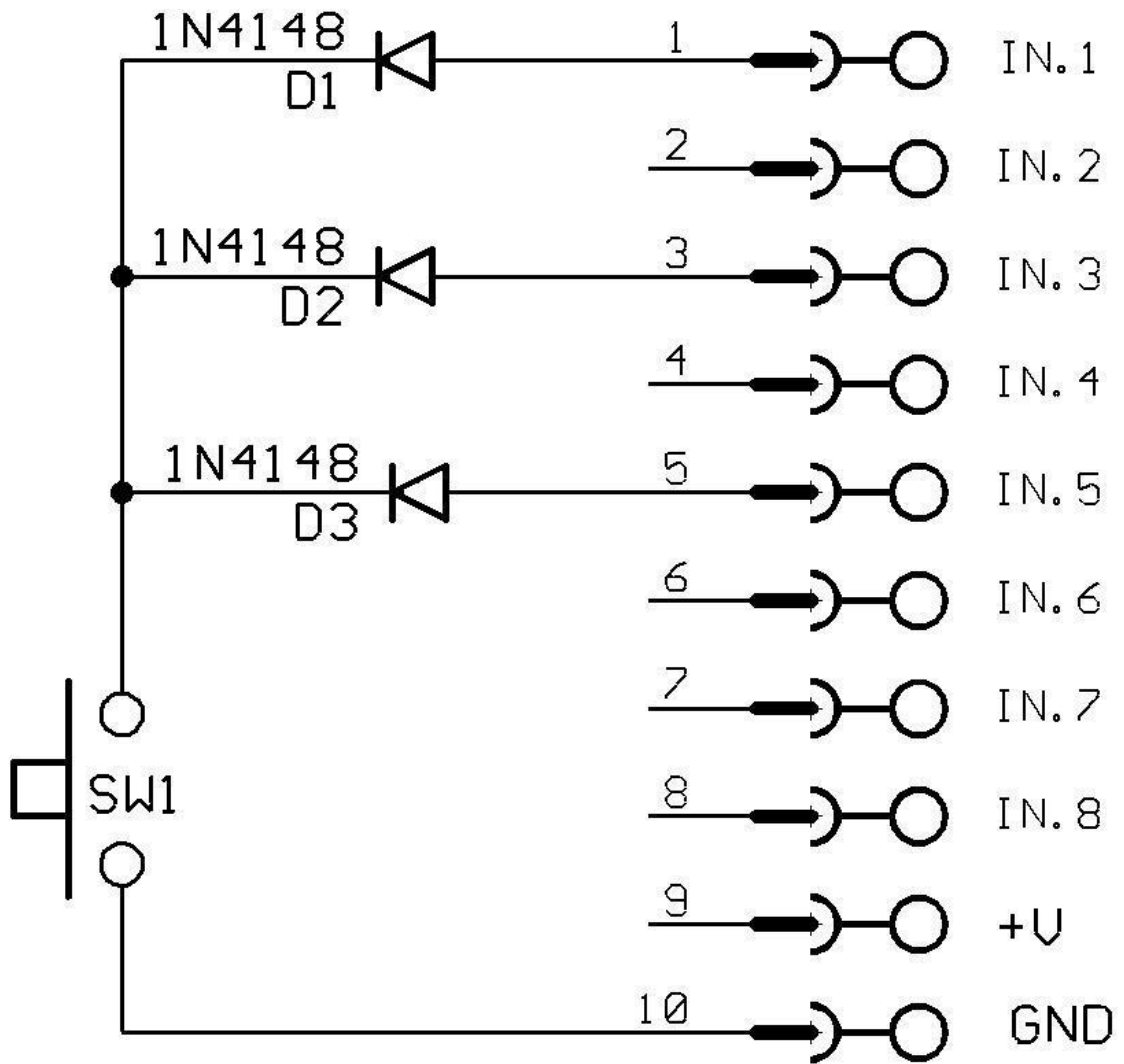

Combination of inputs to play folder 021.

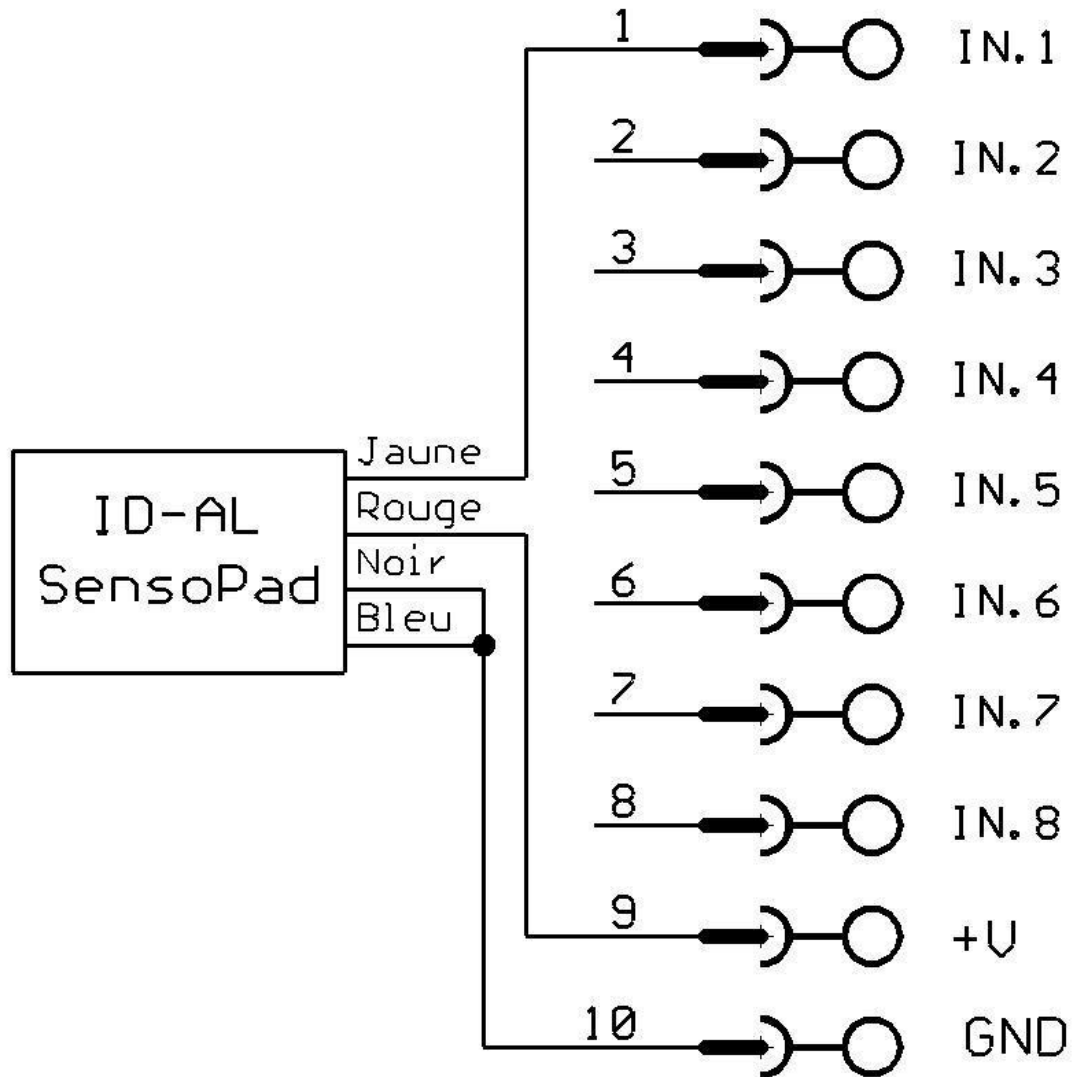

SensoPad connected the player to play folder 001.



+V is directly coming from input voltage. with a 12V voltage, output voltage will be also 12V. Output current will not exceed 500mA.

## 3.2. Output contacts

The player VP330 can actuate output contacts to drive different devices. You can switch on leds, relays, motors .... Output contacts are actuated through tags added to the name of folders. Output contacts are electronically generated by «MOSFET». (refer to scheme below). Max output power is 20V/500mA per output ; overall current limitation is 2A. Output cannot actuate powerfull devices but only low power equipement such as LED or small relays. You shall use an interface between output and the device in case of high power equipments. For example, you can use a relay or an external switch box.

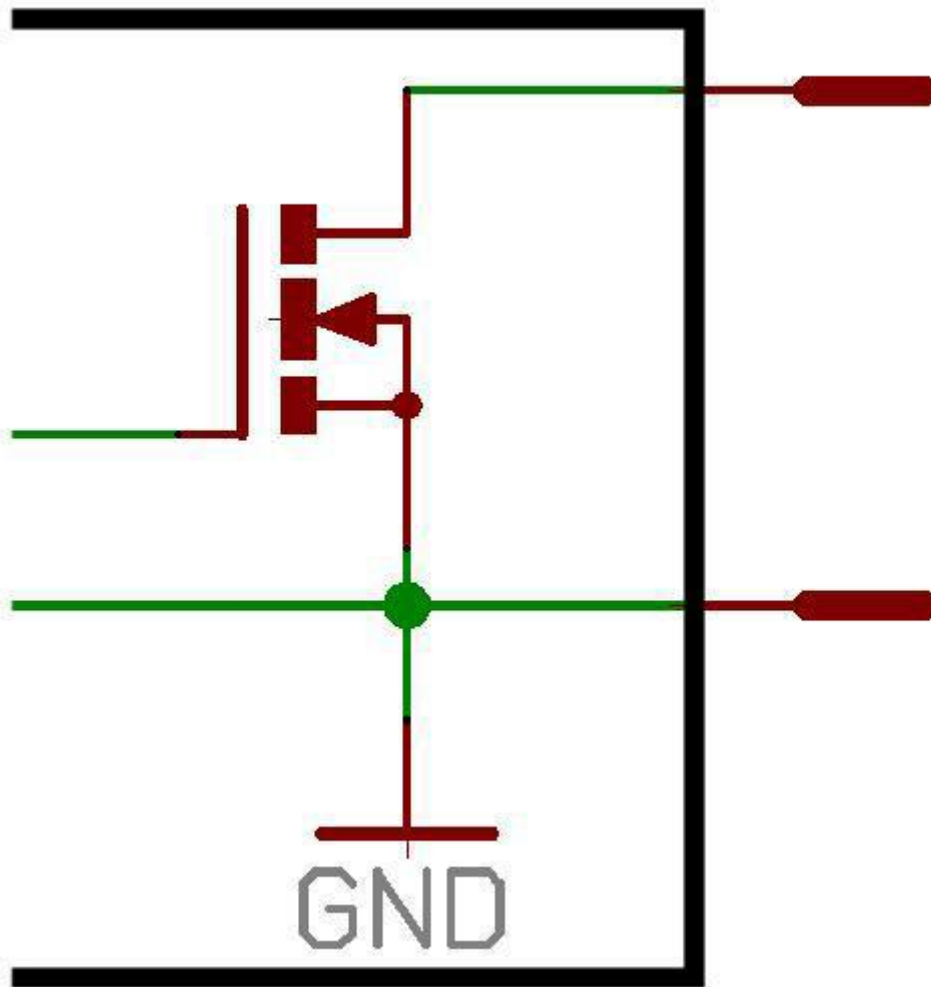

Scheme of one output.

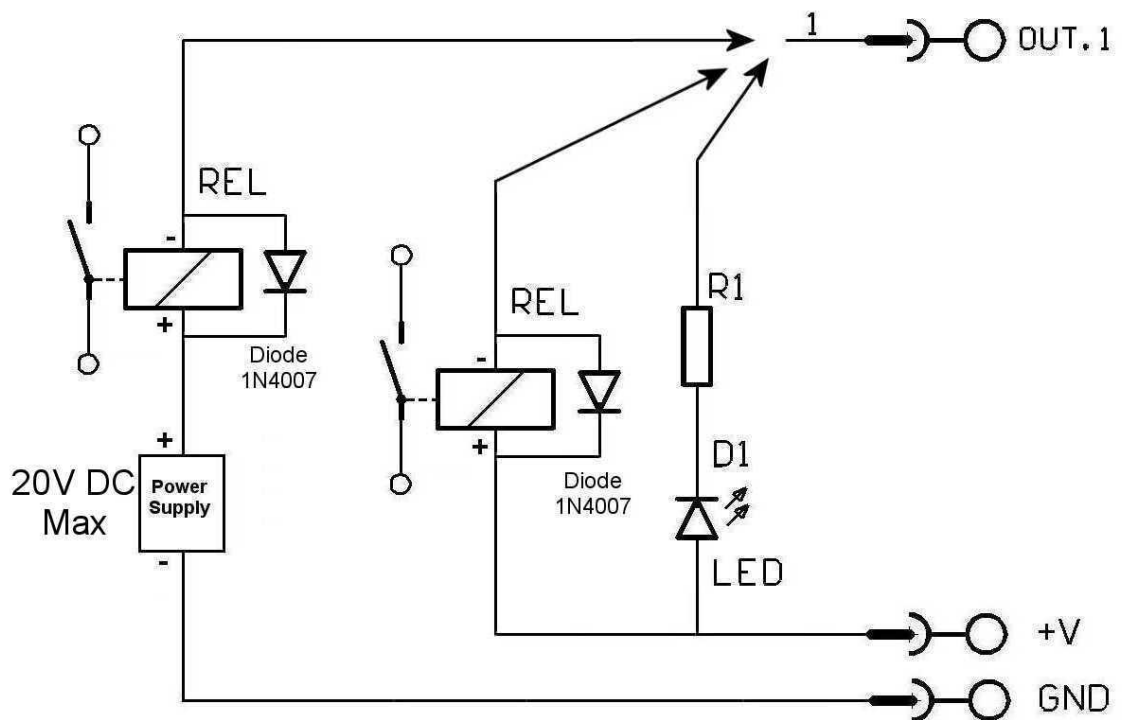

Scheme to switch a LED or a relay with an external power supply.



+V is directly coming from input voltage. with a 12V voltage, output voltage will be also 12V.+Output current will not exceed 1A.



You can also use the 5V output to power a peripheral. Output 5V regulated - Max 1A

## 4. Startup and configuration

This procedure explains how to start and configure your player VP330 for the first time.

### Prérequis

Electric power shall be unplugged.

- 1 Connect the player to the local network.
- 2 Insert your prepared USB key in one of the two USB port at the back of the player.
- 3 Connect a screen, speakers or a sound system on audio line out.
- 4 Power the player by plugging the power connector.

### Résultat

Your player VP330 is now ready to be used.

# 5. Connexion diagram

The following diagram lists all types of connexions available on your player VP330.

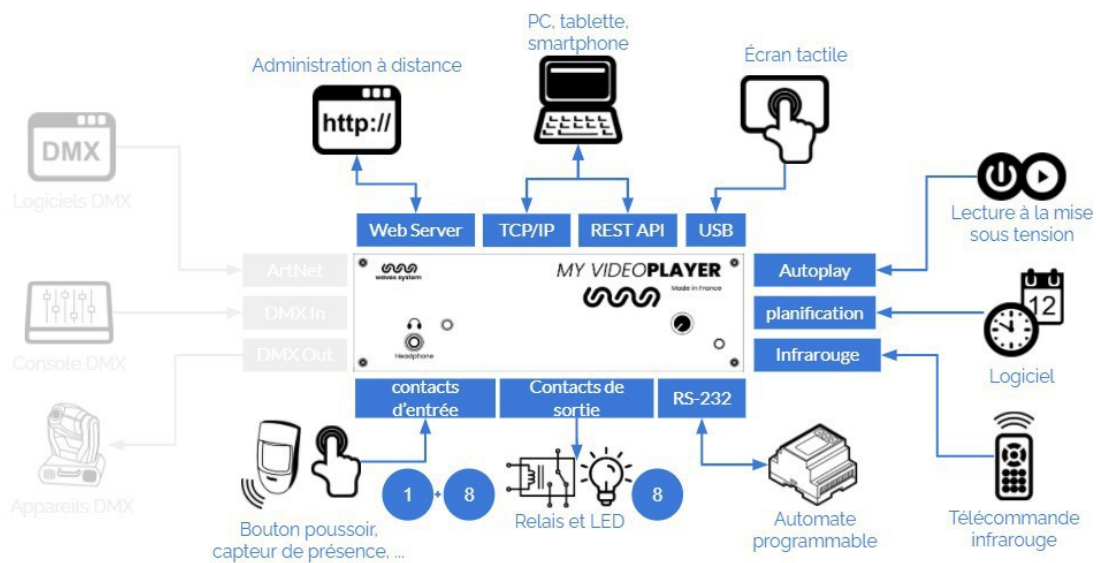

## 6. Set up and update your content media support

You can either choose to use the 4 Gb internal memory or an external support memory such as a SD /SDHC card or a USB key. Each time, the support contains all useful data to broadcast the content. You will find folders and tags, all media, system files and optional files related to your programming (scheduler, web pages, json files).

### **Caution!**

Make sure to use high end quality content media supports. Waves System has only qualified Sandisk manufacturer. We do not recommend Trenscent products.

### 6.1. First setup of removable content support

SD / SDHC cards and USB keys are generally already formatted in FAT or FAT32. But we recommend to perform a new formatting by selecting FAT or FAT32 depending on the storage size (FAT32 over 512 Mo).

Last versions of Windows do not allow to format higher capacities than 32 Go with FAT23 system. In this case, you shall use tier piece of software to do it.

### 6.2. Update content on removable content support

 Please follow the following steps to update your content on the removable content support:

- 1 Switch off the player.
- 2 Remove the content support (SD card or USB key) from the player.
- 3 Connect the content support to your computer.
- 4 Copy, rename, remove files and folders.
- 5 Remove the content support from your computer by using the ejection system of your operating system.
- 6 Insert the content support in the player.
- 7 Power on the player.

### 6.3. Update content directly from your local network

Connect to the remote administration of the player and access directly to the different memories connected to the player. You can drag , drop and edit your content directly on the web interface. Default login is `admin` and default password is `password`. More information in chapter [\[p.49\]](#)  Advanced configuration.

## 7. First steps with your player VP330

### Introduction

The name of folders and files defines the rules of the playback. Folders and files must be named and copied according to specific rules that are described further. This behaviour applies to all types of media (audio, video, web and pictures).

### 7.1. Autoplay

Create a folder named 000 on your removable content support. Copy inside that folder your media such as videos, pictures, audio files. Insert your support in the player. Power on the player. Media files copied in folder 000 are randomly read.

Folder 000 is read by default when powering on the player. At power on, player checks if folder 000 is present. If so, it starts playing the files contained in this folder. If not, the player goes into state "STOP". If you want to loop on folder 000, just add the tag [LOOP] to the name of the folder. If you want to read files sequentially, give a number at the beginning of each filename and add a tag [SEQ] to the name of the folder. (more details on tags below).



Folders LOST.DIR et SYSTEM and file .nomedia are added by the player on the support at the first playback. Do not copy your media in these folders.

### 7.2. Using input contacts of your player VP330

Input contacts are used to trig folders.

VP330 has 1 separated input contact and 8 additional input contacts.



The separated input can be configured in the menu, by default it trigs folder 001.

8 input contacts trig 255 first folders according to a binary order.

Folder N°001 is triggered by separated input contact or by input 1 in the group of 8.

By default 8 input contacts will trig the following folders:

Entry 1 : Folder 001

Entry 2 : Folder 002

Entry 3 : Folder 004

Entry 4 : Folder 008

Entry 5 : Folder 016

Entry 6 : Folder 032

Entry 7 : Folder 064

Entry 8 : Folder 128

If contacts are actuated simultaneously, then 255 folders can be triggered. N°001 to 255 correspond to the combination of 8 input contacts.

### Example to trig folders thanks to 8 input contacts

001 : activate input N° 1

002 : activate input N° 2

003 : activate inputs N° 1 + N° 2

004 : activate input N° 3

005 : activate inputs N° 3 + N° 1

006 : activate inputs N° 3 + N° 2

007 : activate inputs N° 3 + N° 2 + N° 1

008 : activate input N° 4

009 : activate inputs N° 4 + N° 1

and so on following the binary system.

## 7.3. Identify the player on your local network

Use the remote control, press menu and go to System settings > Network to get access to the current IP address of the player.

As an alternative, select OK or Info and read the IP address at the bottom right of your screen. QR code gives you direct access to the remote administration from a smartphone connected to the same network.

## 8. Control the player with folders and files

### 8.1. Arrangement of folders



000 : Folder N° 000 - «Autoplay» folder played at power on

001 : Folder N° 1 - Folder triggered by input contact 1

034 : Folder N° 34

Input contacts trigger folders with the number between 0 and 255 corresponding to the binary code generated by the combination of inputs. You can reassign each input contact to another folder number by using the menu or the remote administration.

Folder N°	Input N°							
	1	2	3	4	5	6	7	8
	Corresponding binary value							
	1	2	4	8	16	32	64	128
001	x							
002		x						
003	x	x						
004			x					
005	x		x					
006		x	x					
007	x	x	x					
008				x				
009	x			x				
010		x		x				
011	x	x		x				
012			x	x				
013	x		x	x				
014		x	x	x				
015	x	x	x	x				
016					x			
017	x				x			
031	x	x	x	x	x			
032						x		
033	x					x		
063	x	x	x	x	x	x		
064							x	
065	x						x	
127	x	x	x	x	x	x	x	
128								x
129	x							x
254		x	x	x	x	x	x	x
255	x	x	x	x	x	x	x	x

Folder 000 is played by default at power on. If this folder is not present, then the player goes to state "STOP".

The folder read by default at power on can be modified in the setting menu.

## 8.2. Add tags to the name of folders to build your scenario

You can add optional tags to the name of the folder to modify the behaviour of the playback. These tags are surrounded by brackets «[> <]». You can have several tags combined together in a folder name.

Tag	Definition
[Jxxx]	Jump to another folder after reading the current folder or loop playback if it jumps to the same folder
[LOOP]	Loop playback, tags are ignored at each loop
[RESUME]	Save the reading position of the files when returning to the folder
[RET]	Return to the previous folder at the end of the playback of the folder
[RND] or [SEQ]	Random or sequential playback mode
[Vx]	Define the absolute volume of the player
[V+x] [V-x]	Define the relative volume of the folder compared to the absolute volume
[NT]	Disable the command events during the playback of the folder
[NRST] ou [NORESTART]	Disable the retrigger of the folder when it is being played
[WHL]	Play the folder while the assigned input combination remains activated
[NXTxxx]	Play the next xxx audio files each time the folder is played
[SUBS x] and [SUBE x]	Activate the display of subtitles at the beginning or at the end of a folder
[WEBS x] and [WEBE x]	Open a webpage at the beginning or at the end of the playback
[WEBS OFF] and [WEBE OFF]	Close a webpage at the beginning or at the end of the playback
[PROJS ON] and [PROJE ON]	Power on a video projector at the beginning or at the end of the playback
[PROJS OFF] and [PROJE OFF]	Power off a video projector at the beginning or at the end of the playback

### ⚠ Case of a folder without tag

The player reads the current folder completely and randomly, then the player goes to state "STOP".

| The folder can be interrupted.

### ⚠ Case of a missing folder

| If a folder is defined by an action but the folder is missing, then the action is ignored.

## 8.2.1. [Jxxx] - Jump to folder xxx at the end of the playback of the folder

This tag defines the behaviour at the end of the playback of the folder. It defines the number of the next folder to be played.

### 👁 Example of loop playback at power on

| 000[J000] : Read files in a loop at the power on.

### 👁 Other examples

| 001[J002] : Jump to folder 002 at the end of the playback of folder 001

| 003[J003] : Jump to folder 003 at the end of the playback of folder 003 ->Loop on folder 003

| 008[J023] : Jump to folder 023 at the end of the playback of folder 008

| 127[J000] : Jump to folder 000 at the end of the playback of folder 127

| At each loop, all tags of the folder are executed.

### 💬 Specific cases

| If targeted folder does not exist, then the playback is stopped at the end.

| A targeted folder can be empty. In this case the playback is instantaneous. Also all tags are executed.

| The playback stops except if it has tags [Jxxx] or [RET] in its name.

## 8.2.2. [LOOP] - Play the folder in loop without the tags at each loop.

This tag executes a loop playback without executing the other tags named in the folder. This tag is of interest if you are using for example tags [RES] or [RSS] to control output contacts. Indeed you avoid unnecessary commutations of outputs in this case.

### 👁 Example

| 001[LOOP]

## 8.2.3. [RESUME] - Save the reading position of the files when returning to the folder

When the player leaves a folder to read another folder and then come back to the first folder, the playlist is reinitialed. In some occasions, you want to restart where the player stopped. For example a folder contains 10 files and the first 5 have been read already. With tag [RESUME], the playback will restart at file 6 and not at file 1.

### 🔍 Example

```
001[RESUME]
```

## 8.2.4. [RET] - Return to the previous folder at the end of the playback of the folder

During the playback of a folder, if an event or a tag orders to play another folder tagged with [RET], then the player jumps to the new folder. At the end of the playback of this new folder, the player jumps back to the initial folder.

This function can be used to resume the playback of a folder interrupted by the playback of a message triggered by an event.

### 🔍 Example

```
001[J100] : Playback of folder 001 then jump to folder 100
```

```
002[J100] : Playback of folder 002 then jump to folder 100
```

```
100[RET] : Playback of folder 100 then goes back to previous folder (001 or 002)
```

In this example, at the end of playback of folder 001 or 002, folder 100 is played, then the player goes to the initial folder (001 or 002).

### 💡 Note

The [RET] tag has only one level of return, i.e. the target folder is always the previously played folder, whatever the number of folders tagged with [RET] played in a row.

## 8.2.5. [RND] or [SEQ] - Sequential or random playback mode

By default, without this parameter, the folder is played in random mode.

[SEQ]: playback the files of the folder, in alphanumerical ascending order (from one to infinite, then A to Z then ato z then special characters and then non ASCII alphabets).

[RND]: playback in a random order.

### 🔍 Example

```
001[SEQ] : Play the folder 001 in sequential mode, then stop
```

```
002[RND][J002] : Play the folder 002 in random mode and in a loop
```

```
003[J001] : Play the folder 003 in random mode, then jump to the folder 001
```

## 8.2.6. [Vx] - Adjust the absolute volume of the folder

This tag modifies the output volume during the playback of the folder. Once the volume is set, it remains unchanged for all next files and folders. If the value exceeds the minimum or the maximum values, then the minimum or the maximum value is applied.

### Example

001[V5] : Fixe la valeur du volume à 5 sur 100 pas disponibles  
 001[V34] : Fixe la valeur du volume à 34 sur 100 pas disponibles  
 001[V100] : Fixe la valeur du volume à sa valeur maximum  
 001[V0] : Fixe la valeur du volume à sa valeur minimum (Mute)

## 8.2.7. [V+x] ou [V-x] - Relative volume of the folder

This tag modifies the volume only during the playback of the folder. When the playback jumps to another folder, the previous volume is set. This feature can be used to increase the volume during an ad for example. Value x can be set between 0 and 100.

### Example

001[V+5][J002] : Increase the volume level by 5 steps during the playback of folder 001 then the volume will be set to previous when jumping to folder 002  
 004[V-24][RET] : Decrease the volume level by 24 steps during the playback of folder 004 then the volume will be set to previous when jumping to previous folder

## 8.2.8. [NT] - Disable the command events during the playback of the folder

With this tag, the files are played and cannot be interrupted, and the received orders are ignored as per the table below:

Command	Source				
	Input	RS-232	Scheduler	wheel click	IR remote control
Change folder	x	x	x	---	
Otherx					

Be careful, the order is not recorded and the trigger information is lost. Some peripherals can remain active despite this tag, this setting can be set in the configuration menu.



Without this tag, the playback of the folder is interrupted by any incoming event (input contact, RS-232, Scheduler, etc.).

### Example

001[NT] : The instructions received are ignored during the playback of the folder 001. Any event coming from input contact, RS-232 or other is ignored, and the playback is not stopped.

### 8.2.9. [NRST] or [NORESTART] - Disable retriggering of a folder when being played

The folder being played cannot be retriggered by an event that trigs this folder. Other orders are taken into account.

### 8.2.10. [WHL] - Play the folder while the assigned input combination remains activated

This tag allows to play the contents of a folder as long as the corresponding input combination is activated. When the input combination associated with the folder is deactivated, the player executes the tags corresponding to the exit of the folder. As long as the corresponding input combination is activated, the folder is played in a loop.

#### Example

001[WHL] : The folder 001 is played in a loop while the input combination 1 is activated. When the input combination 1 is deactivated, the player stops.

002[WHL][J045] : The folder 002 is played in a loop while the input combination 2 is activated. When the input combination 2 is deactivated, the player plays the folder 045.

003[WHL][J999] : The folder 003 is played in a loop while the input combination 3 is activated (inputs 1 and 2 activated). When the input combination 3 is deactivated (inputs 1 and 2 deactivated), the player plays the folder 999.

The dry contact inputs of the player are combinatorial. Therefore, any changes of the input combination are taken into account at any time by the player.

#### Example

000[J000] : The folder 000 is played in a loop on startup

001[WHL][J000] : The folder 001 is played in a loop while the input combination 1 is activated . If input 2 is activated in addition to input 1 , then it activated virtual input 3 and orders the player to read folder 003

002[WHL][J000] : The folder 002 is played in a loop while the input combination 2 is activated . If input 1 is activated in addition to input 2, then it activated virtual input 3 and orders the player to read folder 003

003[WHL][J000] : The folder 003 is played in loop while the input combination of 1 and 3 is activated. If input 1 is deactivated, the players plays folder 002.

### 8.2.11. [NXTxxx] - Play the next xxx media files each time the folder is played

This setting allows to play xxx audio files contained in the folder. Once xxx files have been played, the



player executes the tags at the exit of the folder. If the number of files requested by this tag is greater than the number of files contained in the folder, the player loops in the folder as long as needed in order to play the exact number of files requested.

With this tag, the player memorizes the files already played. This means that the files already played during a previous playback in the folder are not replayed until all files of the folder have been played.

The xxx parameter of the tag [NXTxxx] is the number of files to play in the folder. It is between 001 and 999.

### Example

```
001[NXT003] : 3 files are played in the folder 001, then the player goes to STOP
002[NXT001][J000] : 1 file is played in the folder 002, then the player plays the folder 000
003[NXT005][RET] : 5 files are played in folder 003, then the player goes to the previous folder
004[NXT002][SEQ][J000] : 2 next files are played in the order in folder 004 then the player reads folder 000
```

## 8.2.12. [SUBS x] and [SUBE x] - Define the settings to display subtitles at the beginning or at the end of the playback

These tags define the settings to display subtitles at the beginning or at the end of the playback of a folder. Parameter x can be:

ISO639-1, ISO639-2 or ISO639-3 code of the language to display in subtitles (ex : [SUBS ENG] select and displays english at the start of the playback)

### Example

```
000[SUBS NONE] : videos of folder 000 are played at the power on. Subtitles are deactivated
001[SUBS AUTO] : videos of folder 001 are pplayed with subtitles defined in the global settings of the player
```

## 8.2.13. [WEBS x] and [WEBE x] - Open a webpage at the beginning or at the end of the folder playback

These tags open a webpage (visible or not) at the start or at the end of a folder playback. Parameter x is the page index defined in the `web-config.json` file.

### Example

## 8.2.14. [WEBS OFF] and [WEBE OFF] - Close a webpage at the beginning or at the end of the folder playback

These tags close a webpage (visible or not) at the start or at the end of a folder playback.

## Example

### 8.2.15. [PROJS ON], [PROJE ON], [PROJS OFF] and [PROJE OFF]

These tags power on or power off a video projector at the start or at the end of a folder playback.



Refer to menu  System settings to configure connection with a video projector using PJLink protocol.

### 8.2.16. [RESxxxxxxxx] and [REExxxxxxxx] - Activate or deactivate output contacts

8 output contacts are activated by tag RES at the beginning of the folder or by tag REE at the exit of the folder

[RESxxxxxxxx] : xxxxxxxx represents the state of 8 output contacts that will be activated or deactivated at the beginning of the folder.

[REExxxxxxxx] : xxxxxxxx represents the state of 8 output contacts that will be activated or deactivated at the exit of the folder.

These 2 tags enable to power on lights during the playback and switch them off at the end.

xxxxxxxx represents the 8 outputs: 87654321

If x = 0, output is deactivated, mosfet transistor est locked, current does not go between output and ground GND,

If x = 1, output is activated, mosfet transistor is open and current goes from output to GND,

If x = #, mosfet transistor remains in thte previous state.

## Example

001[RES00000001]: output1 is switched on at the begiining of folder 001

002[REE00000000]: all outputs are switched off at the end of folder 002

003[RES01010101][REE00000000]: Outputs 1,3,5,7 are switched on at the beginning of the folder 003 and switched off at the exit of the folder

### 8.2.17. [RSSxxx] or [RSExxx] - Send bytes through the RS-232 output

When the player starts playing the folder, a frame of bytes is sent through serial link to order other equipments (another player, switching grid, a videoprojector, etc). The bytes to send are included in a text file dedicated to this feature.

Baudrate	Byte(s) for beginning	Byte(s) for data	Byte(s) of parity	Byte(s) for stop	Handshake
19200	1	8	0	1	none

[RSSxxx] : xxxs appoints the line number of the file serial.txt that must be sent (value from 001 up to 999) when player starts to play the folder

[RSExxx] : xxx appoints the line number of the file serial.txt that must be sent at the exit of the folder

The filename containing the bytes must have the following name (mandatory): **serial.txt**

This file must be copied in the folder SYSTEM.



Baudrate can be set in a configuration file named **config.txt**.

Parameter xxx of the tag represents the number of the frame to send (identification of the line in the file **serial.txt**). It is always written on 3 digits between 001 and 999 (example: 001, 045, 999).

The file is a raw text file that can be created by a simple text editor such as Notepad. This file must be saved with "ANSI" encoding. Do not use special characters. Each line contains a frame of bytes written in hexa (from 00h to FFh) separated by a space character.

You shall write only two characters of the hexa .

The beginning of each line is as followed:

#xxx : xxx gives the line number. this figures is set with the the tag in the folder name.

[RSS002] → line #002 - Tag [RSS002] sends the frame of line #002 of file **serial.txt**.

### 🔍 Example of lines contained in the file serial.txt

```
#001:45 85 63 21 78 A5 B2
#002:98 75 21 35 45 98
#100:21 35 45 78 A5 B2
```

You can also add comments at the end of each file by using 2 times the character "/". (// comment).



```
// example file
#001:05 A1 FF E4 // comments
#005:45 85 63 21 78 A5 B2
#100:98 75 35 45 98 // my comment
// other comment
#064: 48 25 Ce 8b
#128:4C 8E D9 5A //
#999:a4 Fc 48 3e 8B
// comments at the end of the file
```



```
001[RSS001] : Sends bytes of line#001 of file serial.txt when starting to play folder 001
002[RSS064] : Sends bytes of line#064 of file serial.txt when starting to play folder 002
```



If the folder is looped with tag [RSSxxx], the message is sent at each loop of the folder.



001[J001][RSS099] : Plays folder 001 in loop. At each loop, message described in line 099 of file **serial.txt** will be sent through RS-232 output

### Voir aussi...

[🔗 RS-232 & TCP/IP communication protocol \[p.55\]](#)

## 8.2.18. Description of folder SYSTEM (optional)

This folder is optional. It contains additional files to customize the player or give it additional features.

SYSTEM\scheduler.tm2 -> File containing the scheduler

SYSTEM\scenario-config.json -> File to index web pages

Other files can be added depending of extensions and specific options of the player.

## 8.2.19. Description of folder WWW (optional)

The folder stores a set of web pages used to be displayed or to run Javascript code.

## 8.3. Arrangement of files inside folders

As for folder, the name of files give the behaviour of the playback



The naming of files is free if you want a random playback («(RND)» tag or no tag in the folder name).

In a sequential playback, files are played in an ascending order. To make sure of the order you can add a number at the beginning of the name. Additional tags can be added to the filename to adapt the scenario as for folders.



001 [J367] my message.mkv

063 [RS020] filename.wav

845 [V+12] my file.mp3

my song [NT].wav

For more information about the format of media files, you can refer the the detailed specification.



Filename	File N°
001.mp3	001
063.wav	063

## 8.4. Add tags to the name of files to build your scenario

You can add optional tags to the name of the files to modify the behaviour of the playback. These tags are surrounded by brackets «[» «]». You can have several tags combined together in a filename.

Tag	Definition
[Jxxx]	Jump to another folder after reading the current file or loop playback if it jumps to the same folder
[RET]	Return to the previous folder at the end of the playback of the file
[Vx]	Define the absolute volume of the player
[V+x] [V-x]	Define the relative volume of the file compared to the absolute volume
[NT]	Disable the command events during the playback of the file
[DUR x] ou [DURATION x]	Define the duration of playback of a picture separately from the diaporama settings
[SUBS x] et [SUBE x]	Activate the display of subtitles at the beginning or at the end of a file
[SYNCHRO]	Synchronize players to start playback simultaneously
[WEBS x] and [WEBE x]	Open a webpage at the beginning or at the end of the playback of a file
[WEBS OFF] and [WEBE OFF]	Close a webpage at the beginning or at the end of the playback of a file
[PROJS ON] and [PROJE ON]	Power on a videoprojector at the beginning or at the end of the playback
[PROJS OFF] and [PROJE OFF]	Power off a videoprojector at the beginning or at the end of the playback

Tag	Definition
[RSSxxx] and [RSExxx]	Send an RS-232 frame at the beginning or at the end of the playback of the file
[RESxxxxxxxx] and [REExxxxxxxx]	Activate or deactivate 8 output contacts at the beginning or at the end of the playback of the file

### 8.4.1. [Jxxx] - Jump to folder xxx at the end of the playback of the file

This tag defines the behaviour at the end of the playback of the file. It defines the number of the next

folder to be played.



my file [J002].mp3 : Jump to folder 002 at the end of the playback of the file.  
 003[J023].mp3 : Jump to folder 023 at the end of the playback of file 003.  
 034[J034].wav : Jump to folder 034 at the end of the playback of file 034. It's not a loop of file 034,  
 but a jump to folder 034.

### 8.4.2. [NT]: Disable the command events during the playback of the file

This tag applied during the playback of the file when added to the filename.

### 8.4.3. [DUR x] or [DURATION x] - Define the duration of playback of a picture

This tag set the duration of a file whatever the global setting of the diaporama. Value x is a number of seconds, value INF or INFINITE set a unlimited duration.

#### 👁 Example

[DUR 60], picture is displayed during 60 seconds  
 [DUR INF], picture is endless displayed  
 [Dur INFINITE], picture is endless displayed  
 [DURATION 15], picture is displayed during 15 seconds  
 [Duration infinite], picture is endless displayed

### 8.4.4. [SUBS x] and [SUBE x] - Define the settings to display subtitles at the beginning or at the end of the playback

These tags define the settings to display subtitles at the beginning or at the end of the playback of a file. Parameter x can be:

ISO639-1, ISO639-2 or ISO639-3 code of the language to display in subtitles (ex : [SUBS ENG] select and displays english at the start of the playback)

#### 👁 Example

000[SUBS NONE] : videos of folder 000 are played at the power on. Subtitles are deactivated  
 001[SUBS AUTO] : videos of folder 001 are played with subtitles defined in the global settings of the player

## 8.4.5. [SYNCHRO] - Synchronize players to start playback simultaneously



Refer to chapter [Synchronize players to start playback simultaneously](#) [p.42]

## 8.4.6. [WEBS x] and [WEBE x] - Open a webpage at the beginning or at the end of the file playback

These tags open a webpage (visible or not) at the start or at the end of a file playback. Parameter x is the page index defined in the `web-config.json` file.

### Example

## 8.4.7. [WEBS OFF] and [WEBE OFF] - Close a webpage at the beginning or at the end of the file playback

These tags close a webpage (visible or not) at the start or at the end of a file playback.

### Example

## 8.4.8. [PROJS ON], [PROJE ON], [PROJS OFF] and [PROJE OFF]

These tags power on or power off a videoprojector at the beginning or at the end of a file playback.

## 8.5. Adding subtitles to videos

You can select and display subtitles files to your videos. The configuration of default subtitles and the graphic edition of subtitles can be done through [Configuration avancée](#). The call of a new subtitle can be done at any time triggered by any kind of event. Thus, the playback is not interrupted when subtitles is changed.

Compatible subtitles format are:

- .srt (SubRip)
- .ssa (SubStation Alpha)
- .ass (Advanced SubStation Alpha)
- .vtt (WebVTT – Web Video Text Tracks)
- .html (Timed Text Markup Language Document)
- .dfxp (Distribution Format Exchange Profile)

### 8.5.1. Naming subtitles in separated files

the subtitle filename is defined by adding the video name to the language name in ISO completed by the extension format.



video name	format	English	subtitle name
loophome.mp4	ISO 639-1	EN	loophome.EN.srt
loophome.mp4	ISO 639-2	ENG	loophome.ENG.srt

### 8.5.2. Encapsulated subtitles

Selection and graphical edition of subtitles is also possible when encapsulated into videos.

### 8.5.3. Select one subtitle on the fly

You can dynamically select subtitles during the playback by programming an input contact, an RS-232 frame, a SDK Javascript, or HTTP order.

## 8.6. Playback a slideshow

Create a slideshow by copying several pictures in a folder. Pictures are played one after the other. The duration of each image is set in chapter [🔗🔗 Advanced configuration](#) <sup>[p.49]</sup>.

## 8.7. Playback of audio files

The playback of audio files can be coupled with the playback of metadata including CD cover or author. La lecture de fichiers audio peut être accompagnée de l'affichage des métadonnées inclusent dans le fichier comme l'image de la jaquette ou l'auteur. Refer to chapter [🔗 Advanced configuration](#) <sup>[p.49]</sup> [🔗](#).

## 8.8. Modification of background image when player is in state "STOP"

By default, background is black when player is in state "STOP" or between two folders. An image can replace the black screen. It must be strictly named waitscreen.jpg in jpg format. The file must be copied in SYSTEM folder at the root of the media.



## 8.9. Using RS-232 serial link

RS-232 serial link enable communication between all Waves System players. It can also be used to dialog whe other equipement such as videoprojectors, automaton, fragrance diffusers. refer to [📄📄📄](#) annex <sup>[p.55]</sup> for protocol details.

## 8.10. Using TCP/IP link

You are able to request a parameter from the player or the player state through ethernet link. Refer to chapter [📄📄📄](#) RS-232 & TCP/IP communication protocol <sup>[p.55]</sup> for more details.

# 9. Synchronize players to start playback simultaneously

## Introduction

All video players can synchronize to start media playback simultaneously. In case of a loop, players will wait each other to start a new loop together. As a first step, you shall activate this option for each player in menu>scenario settings>Playback start synchronization. [SYNCHRO] is the tag to synchronize players by defining Master player, Slaves players and contents to synchronize.

## Groups

You can make work together several groups of players in a unique network by changing their com port. Port 44830 is used by default. This setting is performed in menu  Scenario settings>Playback start synchronisation. All payers having the same port com number will belong to the same group.

For example group 1 gathers all players with port 44830 and group 2 gathers all players with port 44831. Thus when a master player from group 1 sends sync order on the network, all players from group 1 will react.

## Setting Master player

Create folders as for any playback. Inside these folders, complete the filename that will be read as a Master with the tag [SYNCHROxxx].

### Content example for a master player

Create folder 001[J000]

insert following files:

Lion1 [SYNCHRO001].mp4

Cat.mp3

Dog [SYNCHRO002].mov

files with tag [SYNCHRO] will send an order through the network. If other files are inside the folder, They will be read without sending any order. Thus you can playback some files with synchro and some other without.

## Setting a slave player

Create a folder at the root of the media with name «synchro». In this folder, copy your files and add a number at the start of the filename.

### Example of content of a Slave player

Create folder  synchro

insert files :

001 lion2.mp4

002 [J002] Dog2.mov

Slave player behaves as usual with all common features. When it receives a synchro order from a master, it stops the on-going playback to display the expected file.

In previous example, Master player starts playback of file Lion1.mp4 and Slave player starts to play simultaneously the file numbered 001 i.e lion2.mp4

As another example, master player starts the playback of file Dog.mov, Slave player starts to play simultaneously the file numbered 002 Dog2.mov

If some tags are present in the filename of the Slave, they will be executed at the end of the playback.

In this example, Dog2.mov is looped.

# 10. Control the player with a scheduler

## 10.1. Introduction

VP330 can be triggered by a series of date and time. You need to program the calendar of events with our software scheduler that can be downloaded in website [waves-system.com](http://waves-system.com) in msupport menu. The software generates a file that you must copy in the folder SYSTEM of your media storage. The name of the file must remain `📁 scheduler.tm2` as it is defined by default.

## 10.2. Principle

VP330 uses its internal clock to execute actions at due date and time. These actions are stored in a file named `📁 scheduler.tm2`.

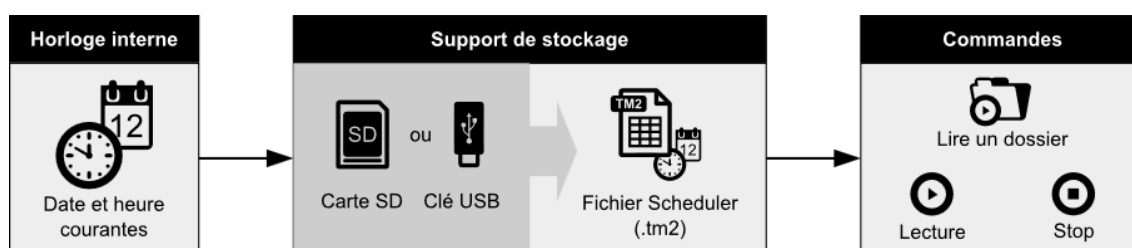

This file contains a calendar from 2016, 1st of January 2016 to 2037, 31st of December. Each day refers to a template day where all actions of a day are described.



If you have no template day for a date in the calendar, then the player will not execute any command for this date.

If you wish the player to execute the same events for several dates, then select the same template day for these dates in the calendar.

A template day lists all events of a day, minute per minute, from 0h00 to 23h59. These events are order that will be executed by the player.

The software Scheduler du VP330 enables to:

- Create several template days,
- insert events every minute in a template day,

An event can execute only one action .

You can choose a command among the following list :

- PLAY FOLDER: Play a folder of files

Select this command and add the folder number between 000 and 999 that you want to play. The tag that are listed in the name of the folder are executed.

- PLAY: Restart the playback

Select this command to restart the playback of the folder where the player stopped previously. This command is ignored if there was no previous command of playback or if the player is in stop mode.

- STOP: Stop the playback

this command stops the playback in the current folder.

- STANDBY: Standby the player.

- WAKE UP: Wake up the player.

- HDMI-CEC STANDBY: Turn off a display device with the HDMI-CEC protocol.

- HDMI-CEC WAKE UP: Turn on a display device with the HDMI-CEC protocol.

- VIDEO PROJECTOR (PJLINK) POWER ON: Turn on a video projector with the PJLINK protocol.

- VIDEO PROJECTOR (PJLINK) POWER OFF: Turn off a video projector with the PJLINK protocol.



You can also configure the HDMI-CEC interaction mode of the player and its display device in menu  `system settings`. Thus the standby of a display device can automatically set the player in standby mode.



Refer to menu  `System settings` to configure connection with a video projector using PJLink protocol.

# 11. Control the player using the HTML5 engine

The player VP330 embeds an HTML5/Javascript engine enabling the display of HTML5/JavaScript contents that can be stored in the player or located in a remote web server. With this feature, you can display local web pages, remote websites and web applications. This content can appear alone or can be displayed on top of the video playback.

The web content can be passive, it can also contain functions to control the player. As an example a button can stop the video or launch a new content. All available functions are already implemented and ready to use through the Javascript API of the player.

You can create any scenario based on this API.

Add a tactile interface to your player by connecting any HDI touchscreen to any of the two USB port.

To know more about the programming and to download examples, refer to the dedicated website [\[http://download.id-al.com/manuals/HTML5\\_JavaScript\\_Engine/en/index.html\]](http://download.id-al.com/manuals/HTML5_JavaScript_Engine/en/index.html) [\[http://download.id-al.com/manuals/HTML5\\_JavaScript\\_Engine/fr/index.html\]](http://download.id-al.com/manuals/HTML5_JavaScript_Engine/fr/index.html)











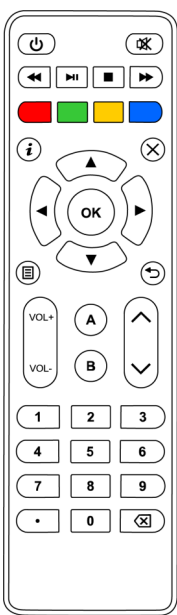









## 12. Settings on front panel

### 12.1. Volume knob

Access to the absolute volume setting of the amplified output through the volume knob.

## 13. Infrared remote control

Le lecteur VP330 est fourni avec une télécommande infrarouge permettant de contrôler le lecteur.

	Touche	Description
		Short press: standby / wake-up. Long press: power off/ restart.
		Mute/Unmute.
		Skip 10 seconds backward/forward.
		Play / pause.
		Stop.
		Programmable buttons. Setup in the menu. Play folder 001 to 004 by default.
		Activate / deactivate display onformation on screen.
		Exit.
		In menu context: up / down. In playback context: next/previous folder.
		In menu context: left / right. In playback context: previous / next file.
		In menu context: validate the selection. During playback: activate / deactivate display of information.
		Activate / deactivate the diplay of the menu.
		Back to previous menu.
		Increase/ decrease the volume.
		Programmable buttons.
		Setting a value.
		In menu context: digit characters. In playback: play folder 0 to 9.
		Dot character.
		Erase previous character.



# 14. Advanced configuration

Player configuration is operated from the display menu on the screen or from the administration console embedded in the player. In this case, use a web browser from a computer connected to the same network and connect to the player ip address.

## 14.1. System info

This menu gives access to player main information:

- Model, serial number, software version and its release date,
- Current date and time,
- The player state, the storage used, the folder and the file being played, the audio volume,
- The power state and the date and time of last power on,
- The list of storages connected, their size and the free space,
- The display state, its resolution, its format and colour depth,
- The state of the video projector connected to the player through PJLink protocol,
- Network parameters,
- Printer state.

## 14.2. System settings

Set new parameters to the player through this menu.

### 14.2.1. Playback engine

#### **Storage device**

Select the storage to use at startup.

#### **Slideshow image duration**

Set how long still images appear in a slideshow, by default 5 sec, can be set between 1 sec and infinite.

#### **Audio artworks**

Display artworks embedded in audio files metadata.

### 14.2.2. Log

Activate log on the screen to display all the events of the player.

## 14.2.3. Network

### 14.2.3.1. IP settings

Obtain an IP address automatically (DHCP) or use manual settings (static).

#### 14.2.3.1.a. Proxy settings

Set the proxy server configuration mode.

## 14.2.4. Display

### 14.2.4.1. Resolution

Enable this setting to let the device choose the best display resolution.

#### 14.2.4.2. Display aspect

Set the zoom level to adjust the visible area.

Set the video resizing method to fit the video to the display format.

#### 14.2.4.3. Dynamic range

Set the conversion strategy from High Dynamic Range to Standard Dynamic Range and vice versa.

#### 14.2.4.4. Custom video display area

Resize the video for non conventional screen sizes such as LED screens. Origin coordinate, pixel height and width and rotating angle can be adjusted.

## 14.2.5. HDMI CEC

By using a screen with CEC standard, the player can communicate with the device in both ways and send orders to wake up or standby.

## 14.2.6. Video projector

Through this menu, you can detect a video projector connected to the same network compatible with PLink protocol. Enable the function, then enter the video projector IP address. You can also launch an automatic search of video projectors . If needed, you can also enter the password of the video projector.

## 14.2.7. Sound

System sounds can be removed. Multichannel audio can be converted into stereo, or broadcasted as they are, or adjusted to the capabilities of the connected HDMI device. HDMI audio output format can be PCM or bitstream.

## 14.2.8. Subtitles

Select subtitles display among 3 modes:

modalité	details	example
Enabled	Show subtitles when available	
Forced subtitles only	Show only forced subtitles	An original version of a video can embed subtitles even when subtitles are deactivated (elven is subtitled in english in the Lord of the rings).
Disabled	Never show subtitles	

The first favorite language will be displayed if present.

The second favorite language will be displayed if the first favorite language is missing.

An embedded editor can modify the visual rendering of the subtitles.

## 14.2.9. Serial port

Set the serial port speed between 1200 and 115200 bps. Activate daisy chain mode to forward the data received on the serial port input to the serial port output. Set the identifier related to the serial link protocol.

## 14.2.10. Input contacts

Choose the input contacts that are normally open.

## 14.2.11. Printer

The player is compatible with Star TSP100 printer. Set the paper size used with this printer.

## 14.2.12. FTP server

Set a new login and a new password to access the embedded FTP server.

### 14.2.13. Web browser

Enable the web inspector for remote debugging. You can connect to it using Chrome or Chromium on port 9222.

Enable the system virtual keyboard.

### 14.2.14. Date and time

You can synchronize the device clock with a time server (requires internet connectivity) or with a computer. Select the timezone and the format of hours.

### 14.2.15. Language

Select between French and English (US).

### 14.2.16. Device identification

Give a name to your player through this menu.

### 14.2.17. Boot sequence

Display or not the animation and logo at power on.

### 14.2.18. System update

Update the firmware through the web if the player is connected to internet.

You can also erase all data from your device's internal storage, including system settings and multimedia files.

## 14.3. Scenario settings

### 14.3.1. Startup volume

Set the volume level when starting the scenario.

### 14.3.2. Autoplay folder

Select the folder number to play when starting the scenario, by default folder 0 is played.

### 14.3.3. Sources blocked by [NT]

Select the event sources that cannot interrupt the playback of a file flagged with an [NT] tag.

### 14.3.4. Input contacts



You can set a specific action to any combined input contacts. For example, read a folder, decrease the volume, go to standby, ...

By default each combined input contact select a folder to play.

### 14.3.5. Remote control

Assign actions to the following remote control buttons : red, green, yellow, blue, A and B.

### 14.3.6. Playback start synchronisation

Activate this feature in this menu. The port defines the player synchronization group. All the players in this group can synchronize playback together. To know more refer to   chapter "Synchronize players to start playback simultaneously" [p.42].

### 14.3.7. Volume notifications

The selected event sources can make the volume bar and the mute indicator visible.

### 14.3.8. Websites

The form is used to add new websites and automatically create the json file that indexes all web pages. You may enter any http or https URL as long as the content provider can be trusted.

Websites can be displayed using the [WEBS x] and [WEBE x] tags on media files and folder names.

To display content stored on the connected media storage, copy your HTML content into the "www" folder, then create a website using a URL prefixed with "http://localhost/www/".

## 14.4. System control

### 14.4.1. Video playback

Control the playback of the player, select a folder to play and adjust the volume.

## 14.4.2. Power state

Select if you want to go to standby, wakeup from standby or restart the player. You can also standby or wake up a CEC compatible monitor. Finally you can power on or power off a video projector compatible with PLink protocol.

## 14.4.3. Neighborhood

The list of neighboring Waves System devices can be updated by clicking on the Refresh button.

## 14.4.4. Console

## 14.4.5. File manager

This screen gives direct access to all storage locations to create, edit , rename and to drag and drop content.

## 15. RS-232 & TCP/IP communication protocol

The player VP330 can communicate with other Waves System players. It can receive commands from input Rx and send commands and data through output Tx. The player complies with RS-232 standard. All players have the address 0x80 when they leave the warehouse. The first byte of a command is set to 0x80 to be received by all players. You can also change the player address so it can receive its dedicated commands.

Player can receive commands to start playback or change subtitles for example.

Receiving protocol is built from a 3 byte frame minimum.

Baudrate (bds)	Byte(s) of start	data byte(s)	Parity byte(s)	Byte(s) of stop	Handshake
from 1200 to 115200	1	8	0	1	None

The player can also receive commands from its TCP port 65079.



The baudrate can be modified in menu  System settings>serial port.

### Reminder

- A byte is defined by 8 bits : b7 b6 b5 b4 b3 b2 b1 b0.
- The representation of a byte is written 10000000b en binary, or 80h in hexa.

## 15.1. Player control commands

### 15.1.1. Jump to a folder

Byte	Role	Value (represented in hexa)	Description
0	Synchro	0x80   id	Sync byte and player ID
1	Command	0x01	Command to jump to a folder with a number between 000 and 127
		0x11	Command to jump to a folder with a number between 128 and 255
		0x21	Command to jump to a folder with a number between 256 and 383
		0x31	Command to jump to a folder with a number between 384 and 511
		0x41	Command to jump to a folder with a number between 512 and 639
		0x51	Command to jump to a folder with a number between 640 and 767
		0x61	Command to jump to a folder with a number between 768 and 895
		0x71	Command to jump to a folder with a number between 896 and 999
2	Parameters	[0x00-0x7F]	Folder number in the range of the command. Parameter = folder number-initial value of the range. Value comprised between 0 and 127.



0x81 0x41 0x7C is the command sent to player 001 to jump to folder 636.



## 15.1.2. Play and standby

Byte	Role	Value (represented in hexa)	Description
0	Synchro	0x80   id	Sync byte and player ID
1	Command	0x02	Command to play and to standby
2	Parameters	0x01	PLAY - play from the start of the file
		0x02	Stop
		0x03	Next file in the current folder
		0x04	Previous file in the current folder
		0x05	Pause / Play
		0x06	Play next folder
		0x07	Play previous folder
		0x08	Standby / wake up
		0x09	Increase the volume by one step
		0x0A	Decrease the volume by one step
		0x0B	Not in use
		0x0C	Standby
		0x0D	Wake up
		0x0E	Pause
		0x0F	Resume playback after a pause
		0x10	Mute or Unmute the sound of the audio output
		0x11	Mute the sound of the audio output
		0x12	Unmute the audio output to its previous level
0x13	Set standby order to the screen through HDMI-CEC. Be careful: the screen can ask the player to standby in return.		
0x14	Power on the screen through HDMI-CEC (One touch play). Player wakes up with this command if necessary.		
0x15	Standby or power on the screen through HDMI-CEC in regards with the context		
0x16	Power on video projector using PJLINK protocol		
0x17	Power off video projector using PJLINK protocol		



Refer to menu  **System settings** to configure connection with a video projector using PJLink protocol.

### 15.1.3. Set the volume

Byte	Role	Value (represented in hexa)	Description
0	Synchro	0x80   id	Sync byte and player ID
1	Command	0x03	Command of the volume
2	Parameter	[0x00-0x64]	Set volume between 0 and 100

### 15.1.4. Request information

Player can send information upon a request received by RS-232 communication.

Byte	Role	Value (represented in hexa)	Description
0	Synchro	0x80   id	Sync byte and player ID
1	Command	0x04	Command to request information
2	Parameter	0x01	Player state-> PLAYING / STOP / PAUSE / ERROR
		0x02	Filename of the current file. If state "stop", the filename of the last played file.
		0x03	Filename and path in the storage - Example : 001/bird.mp4
		0x04	Used media -> USB / SD / internal memory
		0x05	Not in use
		0x06	Foldername of the current playback -> 001 to 999 - Example : 005
		0x07	Not in use
		0x08	Not in use
		0x09	remaining time for a played file -> hh:mm:ss - Example : 00:05:14
		0x0A	total time of a played file : hh:mm:ss - Example : 01:42:27
		0x0B	Player volume-> xx (0 to 100) - Example : 16

Player sends data in ASCII format on Tx . CR/LF (carriage return/ line feed) is sent at the end of the frame.



Frame sent to the player to request player status: 0x81 0x04 0x01

Byte 1 : 0x81 : Byte of status, player number 001

Byte 2 : 0x04 : command to request information

Byte 3 : 0x01 : ask player status



Frame sent to the player to request player the remaining time of the file: 0x82 0x04 0x09

Byte 1 : 0x82 : Byte of status, player number 002

Byte 2 : 0x04 : command to request information

Byte 3 : 0x09 : ask remaining time

Player answers : 00:03:12 + CR/LF (in ASCII format) = 30 30 3A 30 33 3A 31 32 0D 0A (in Hex)

## 15.2. Update the clock

### 15.2.1. Update the local time

This command sets the hour in the local time zone of the player.

Byte	Role	Value (represented in hexa)	Description
0	Synchro	0x80   id	Sync byte and player ID
1	Command	0x0C	Update local hour
2	Hours	[0x00-0x17]	Number of hours since midnight between 0 and 23
3	Minutes	[0x00-0x3B]	Number of minutes since the start of the hour between 0 and 59
4	Seconds	[0x00-0x3B]	Number of seconds since the start of the minute between 0 and 59

### 15.2.2. Update the local date

This command sets the date in the current time zone of the player.

Be careful, by setting a new date you can affect the hour (winter time and summer time).

Byte	Role	Value (represented in hexa)	Description
0	Synchro	0x80   id	Sync byte and player ID
1	Command	0x1C	Update the local date
2	Year	[0x00-0x7F]	Number of elapsed years since year 2000, between 0 and 127
3	Month	[0x01-0x0C]	Month of the current year between 1 and 12
4	Day	[0x01-0x1F]	Day of the current month between 1 and 31

### 15.2.3. Update the local date and time

This command sets the date and time in the time zone of the player.

It's actually a combination of the 2 previous commands.

Byte	Role	Value (represented in hexa)	Description
0	Synchro	0x80   id	Sync byte and player ID
1	Command	0x2C	Update the local date and time
2	Year	[0x00-0x7F]	Number of elapsed years since year 2000, between 0 and 127
3	Month	[0x01-0x0C]	Month of the current year between 1 and 12
4	Day	[0x01-0x1F]	Day of the current month between 1 and 31
5	Hours	[0x00-0x17]	Number of hours since midnight between 0 and 23
6	Minutes	[0x00-0x3B]	Number of minutes since the start of the hour between 0 and 59
7	Seconds	[0x00-0x3B]	Number of seconds since the start of the minute between 0 and 59

#### 15.2.4. Update the UTC/GMT date and time (epoch version)

This command sets the hour whatever the time zone of the player. It is based on a epoch reference given in seconds since 1970, Jan 1st at midnight UTC/GMT.

Epoch value is given through bytes 2 to 6. To conform it to the protocol (sync byte 0x80), the value of each byte must be set between 0 and 127.

Byte	Role	Value (represented in hexa)	Description
0	Synchro	0x80   id	Sync byte and player ID
1	Command	0x3C	Update UTC date and time
2	Epoch bits 28-34	[0x00-0x7F]	((epoch >> 28) & 0x7F)
3	Epoch bits 21-27	[0x00-0x7F]	((epoch >> 21) & 0x7F)
4	Epoch bits 14-20	[0x00-0x7F]	((epoch >> 14) & 0x7F)
5	Epoch bits 7-13	[0x00-0x7F]	((epoch >> 7) & 0x7F)
6	Epoch bits 0-6	[0x00-0x7F]	(epoch & 0x7F)

#### 15.2.5. Update the UTC/GMT date and time (complete version)

This command sets the hour whatever the time zone of the player with a usual UTC/GMT format understandable by humans.

Byte	Role	Value (represented in hexa)	Description
0	Synchro	0x80   id	Sync byte and player ID
1	Command	0x4C	Update UTC/GMT date and time
2	Year	[0x00-0x7F]	Number of elapsed years since year 2000, between 0 and 127
3	Month	[0x01-0x0C]	Month of the current year between 1 and 12
4	Day	[0x01-0x1F]	Day of the current month between 1 and 31
5	Hours	[0x00-0x17]	Number of hours (UTC/GMT) since midnight between 0 and 23
6	Minutes	[0x00-0x3B]	Number of minutes (UTC/GMT) since the start of the hour between 0 and 59
7	Seconds	[0x00-0x3B]	Number of seconds (UTC/GMT) since the start of the minute between 0 and 59

### 15.2.6. NTP activation/deactivation

This command activates or deactivates the automatic update of the clock through the network. You shall manually deactivate the automatic update before using the command to set date and time manually.

Byte	Role	Value (represented in hexa)	Description
0	Synchro	0x80   id	Sync byte and player ID
1	Command	0x5C	Update UTC/GMT date and time
2	Activation	[0x00-0x01]	0 to deactivate NTP, 1 to activate

## 15.3. Command to select subtitles

### 15.3.1. Generic command to select subtitles

Byte	Role	Value (represented in hexa)	Description
0	Synchro	0x80   id	Sync byte and player ID
1	Command	0x0D	Command to select subtitles
2	Parameters	0x00	Deactivate subtitles
		0x01	Activate automatic selection of subtitles according to system settings
		0x02	Select previous subtitles (no loop)
		0x03	Select next subtitles (no loop)
		0x04	Select previous subtitles (with loop)
		0x05	Select next subtitles (with loop)

### 15.3.2. Select a subtitle track with language code

Byte	Role	Value (represented in hexa)	Description
0	Synchro	0x80   id	Sync byte and player ID
1	Command	0x1D	Manual selection manuelle of subtitles according to language code ISO-639
2	Language code	[0x61-0x7A]	First byte is the ASCII value of the character string of the language code ISO-639 between "a" and "z"
3	Language code	[0x61-0x7A]	Second byte is the ASCII value of the character string of the language code ISO-639 between "a" and "z"
4	Language code	[0x61-0x7A]	Thirsd byte is the ASCII value of the character string of the language code ISO-639 between "a" and "z"



### 15.3.3. Select a subtitle track using track index

Byte	Role	Value (represented in hexa)	Description
0	Synchro	0x80   id	Sync byte and player ID
1	Command	0x2D	Manual selection of subtitles according to language code ISO-639
2	Language code	[0x00-0x7F]	Track index between 0 and 127

### 15.3.4. List all subtitle tracks

This is an extension of the info request.

Byte	Role	Value (represented in hexa)	Description
0	Synchro	0x80   id	Sync byte and player ID
1	Command	0x04	Manual selection of subtitles according to code language ISO-639
2	Subcommand	0x41	List all subtitle tracks

Return value: list of ISO-639 language codes splitted by semicolon and ended by CRLF.

#### Example

```
| eng;ara;nld
```

## 15.4. Unitary transmission mode and daisy chain



VP330 can send several kinds of data through RS-232 port.

- specific data using tags [RSxxx].
- command frames retransmitted in « Daisy Chain » mode.

Default mode

Only data using [RSxxx] are sent through Tx output.

- « Daisy Chain » Mode

With this mode, all data entering through Rx are retransmitted through Tx. Use this mode when you chain players. Connect Tx output of a player to Rx input of another player. Data received by the first player is sent to the second player. You can activate this mode by referring to chapter   Advanced configuration <sup>[p.49]</sup>.

**⚠ Warning**

| Some delay appears if many players are connected to each other.