

PRM-UST | PRM-USTB



Table of contents

1	Important product information	4
1.1	Safety information	4
1.2	Disposal instructions	4
1.3	Class A Notice for FCC and ICES 003	4
1.4	Compliance to directive 2014/53/EU	5
2	About this manual	6
2.1	Intended audience	6
2.2	Copyright notice	6
2.3	Trademarks	6
2.4	Notice of liability	6
2.5	Document history	6
3	Product introduction	7
3.1	Parts included	7
3.2	Installation	9
3.3	Indicators and connections	9
3.3.1	Front panel	9
3.3.2	Rear panel	10
3.3.3	Remote control	11
4	Product function	13
4.1	FM Tuner	13
4.2	USB or SD	15
4.3	Bluetooth®	16
5	Troubleshooting	17
6	Technical data	19

1 Important product information

1.1 Safety information

1. Read and keep these safety instructions. Follow all instructions and heed all warnings.
2. Download the latest version of the applicable installation manual from www.boschsecurity.com for installation instructions.



Information

Refer to the Installation Manual for instructions.

3. Follow all installation instructions and observe the following alert signs:



Notice! Containing additional information. Usually, not observing a notice does not result in damage to the equipment or personal injuries.



Caution! The equipment or the property can be damaged, or persons can be injured if the alert is not observed.



Warning! Risk of electric shock.

4. System installation and servicing by qualified personnel only, in accordance with applicable local codes. No user-serviceable parts inside.
5. System installation for emergency sound (except for call stations and call station extensions) in a Restricted Access Area only. Children may not get access to the system.
6. For rack-mounting of system devices, make sure that the equipment rack is of suitable quality to support the weight of the devices. Use caution when moving a rack to avoid injury from tip over.
7. The apparatus shall not be exposed to dripping or splashing and no objects filled with liquids, such as vases, shall be placed on the apparatus.



Warning! To reduce the risk of fire and electric shock, do not expose this apparatus to rain or moisture.

8. Mains powered equipment shall be connected to a mains power outlet socket with a protective earthing connection. An external, readily operable, mains plug or all-pole mains switch shall be installed.
9. Only replace the mains fuse of an apparatus with a fuse of the same type.
10. The protective ground connection of an apparatus shall be connected to protective ground before the apparatus is connected to a power supply.

1.2 Disposal instructions



Old electrical and electronic appliances.

Electrical or electronic devices that are no longer serviceable must be collected separately and sent for environmentally compatible recycling (in accordance with the European Waste Electrical and Electronic Equipment Directive).

To dispose of old electrical or electronic devices, you should use the return and collection systems put in place in the country concerned.

1.3 Class A Notice for FCC and ICES 003

applies to U.S.A. and Canadian models only



Business Equipment **For commercial or professional use**

This equipment has been tested and found to comply with the limits for a Class A digital device, pursuant to Part 15 of the FCC and Canadian ICES-003 requirements. These limits are designed to provide reasonable protection against harmful interference when the equipment is operated in a commercial environment. This equipment generates, uses, and can radiate radio frequency energy and, if not installed and used in accordance with the instruction manual, may cause harmful interference to radio communications. Operation of this equipment in residential area is likely to cause harmful interference in which case the user will be required to correct the interference at their own expense. Intentional or unintentional changes or modifications not expressly approved by the party responsible for compliance shall not be made. Any such changes or modifications may void the user's authority to operate the equipment.

1.4

Compliance to directive 2014/53/EU

Hereby, Bosch Security Systems B.V. declares that this product is in compliance with essential requirements and other relevant provisions of Directive 2014/53/EU.

This product is allowed to be used in all EU member states.

Frequency bands	Maximum output power
2402 — 2480 MHz (EDR)	2.27 dBm
2402 — 2480 MHz (BLE)	1.41 dBm

2 About this manual

The purpose of this user manual is to provide all required information needed for the installation and configuration of the Bosch music source products PRM-UST and PRM-USTB.

2.1 Intended audience

This user manual is intended for professionals familiar with audio systems.

2.2 Copyright notice

Unless otherwise indicated, this publication is the copyright of Bosch Security Systems B.V. All rights are reserved.

2.3 Trademarks

Throughout this document trademark names may have been used. Rather than put a trademark symbol in every occurrence of a trademark name, Bosch Security Systems states that the names are used only in an editorial fashion and to the benefit of the trademark owner with no intention of infringement of the trademark.

2.4 Notice of liability

While every effort has been taken to ensure the accuracy of this document, neither Bosch Security Systems nor any of its official representatives shall have any liability to any person or entity with respect to any liability, loss or damage caused or alleged to be caused directly or indirectly by the information contained in this document.

Bosch Security Systems reserves the right to make changes to features and specifications at any time without prior notification in the interest of ongoing product development and improvement.

2.5 Document history

Release date	Documentation version	Reason
XX.2021	1 st version	Content creation

3 Product introduction

Bosch’s PRM-UST and PRM-USTB are professional multisource music players intended to be used as background music sources for public address and commercial audio applications. Both products have USB interface, SD card input for playing stored music files, and tuner for FM frequency band broadcast. Additionally, PRM-USTB facilitates music streaming through Bluetooth®*.



Notice!

PRM-USTB is available only in selected countries.
Contact your nearest Bosch dealer or distributor for more information

*The Bluetooth® word mark and logos are registered trademarks owned by Bluetooth SIG, Inc. and any use of such marks by Bosch Security Systems, Inc. is under license. Other trademarks and trade names are those of their respective owner.

3.1 Parts included

The box contains the following parts:

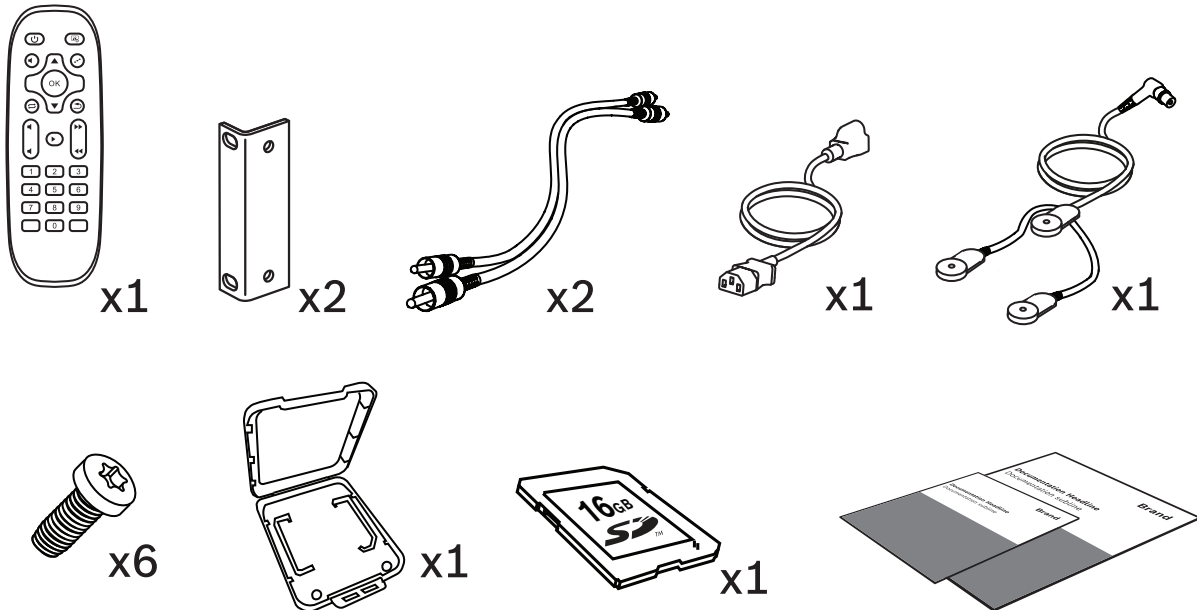
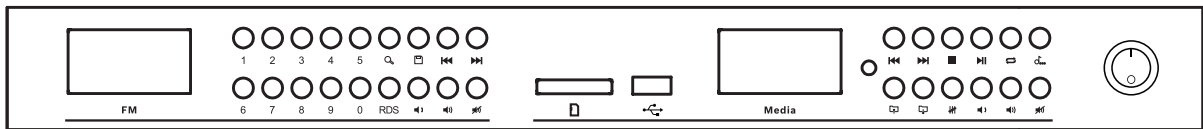

Quantity	Component
1	Music Source PRM-UST or PRM-USTB
1	Remote control (battery not included)
1	Set of 19” mounting brackets with screws
2	Stereo RCA audio cable

Quantity	Component
1	Mains power cord
1	Antenna cord including connector
1	SD memory card (16 GB)
1	Quick installation guide
1	Safety information

3.2 Installation

The product can be placed on a desk or mounted in a 19" rack. For rack mounting the 19" brackets must be attached first.

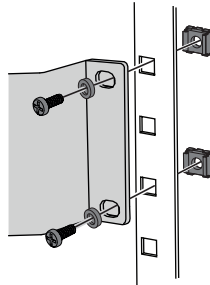

3.3 Indicators and connections

3.3.1 Front panel

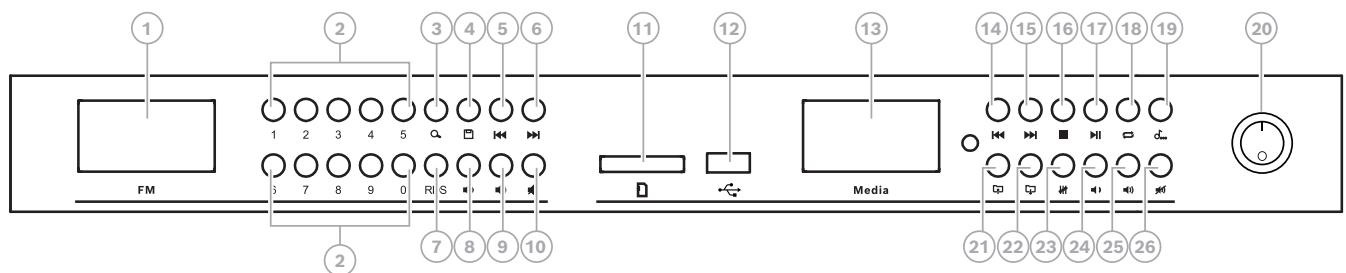

Number	Description
1	Display (FM radio): LCD panel shows information related to FM radio
2	Digits 0-9 for preset (favorite) radio station selection or for playing a specific FM frequency
3	Scan the FM radio stations Display shows the frequency for the stations while scanning is in progress
4	Store a specific frequency channel as preset (favorite), in combination with the digit keys
5	Short press: previous radio channel Long press: decrease frequency for fine tuning
6	Short press: next radio channel Long press: increase frequency for fine tuning
7	RDS information
8	Decrease radio volume
9	Increase radio volume
10	Mute FM radio audio output
11	SD card socket

Number	Description
12	USB socket Note: Do not use the front and rear panel USB sockets at the same time
13	Display (media): LCD panel shows relevant information for media inputs USB, SD and Bluetooth®
14	Short press: previous track Long press: fast backward
15	Short press: next track Long press: fast forward
16	Stop
17	Play or pause
18	Repeat a track or a list
19	Media source selection from USB, SD or Bluetooth®
20	Power on/off
21	Short press: previous folder
22	Short press: next folder
23	Tone control (Equalizer, Bass, Treble, Balance and Loudness)
24	Decrease media volume
25	Increase media volume
26	Mute media audio output

3.3.2

Rear panel

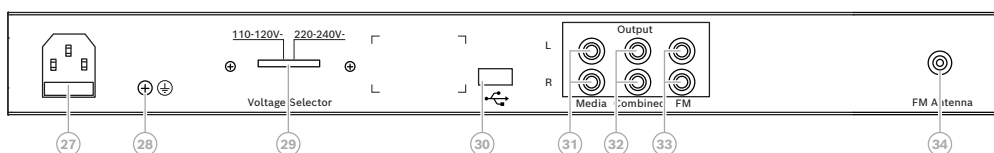

Number	Description
27	Mains input socket with fuse folder
28	Grounding screw
29	Voltage selector switch with cover
30	USB socket Note: Do not use the front and rear panel USB sockets at the same time
31	Media output: USB, SD or Bluetooth (stereo output)
32	Combined output: tuner, USB, SD or Bluetooth® (stereo output) Note: Due to priority output function, when the media (USB, SD, Bluetooth®) is active, the tuner audio output will be automatically muted
33	Tuner output socket (stereo output)

Number	Description
34	To connect the FM antenna (75 ohm)

**Notice!**

Do not use the USB socket to charge other devices. It has an output current limited at 500 mA.

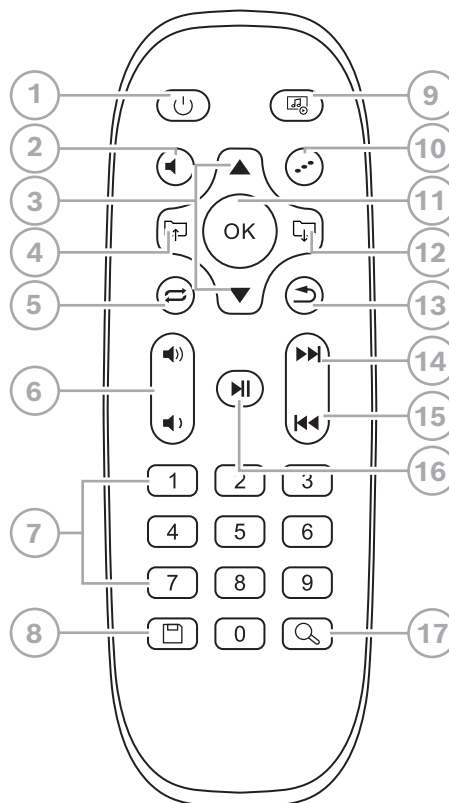
3.3.3**Remote control**

Number	Description
1	Turn on/off the LCD panels
2	Mute all music sources
3	Decrease or increase tone control (Equalizer, Bass, Treble, Balance and Loudness)
4	Previous level folder
5	Repeat a track or a list
6	Increase and decrease volume of the selected music source
7	0-9: Digits for radio frequency preset radio station selection or playing a specific frequency

Number	Description
8	Short press: stores a specific frequency channel as favorite, in combination with the digit keys Long press: opens RDS information for FM
9	Select the music source: Tuner -> USB -> SD-> BT -> Tuner
10	Tone control (Equalizer, Bass, Treble, Balance and Loudness)
11	Confirm selection
12	Next level folder
13	Back to previous menu
14	Short press: next track Long press: fast forward
15	Short press: previous track Long press: fast backward
16	Play or pause
17	Scan the FM radio stations Display shows the frequency for the stations while scanning is in progress

To insert the batteries (2x 1,5V, size AAA):

1. Remove the battery compartment cover on the rear side of the remote control.
2. Insert the batteries as indicated in the battery compartment.
3. Close the battery compartment with the cover.



Notice!

If the remote control is not in use for a longer period of time, remove the batteries to prevent any damage due to battery leakage.



Notice!

Disposable batteries and battery packs at the end of their technical lives should be discarded with due care for the environment. When possible, take batteries to a local recycling station.

4 Product function

4.1 FM Tuner

The FM tuner supports the frequency band of 87.5 to 108.0 MHz.

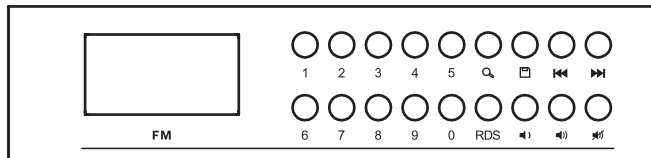

Operation

- Connect the antenna

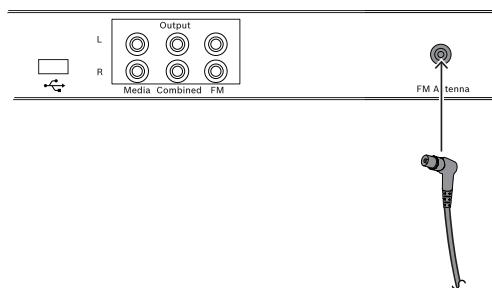

- To scan the radio channels, press the button from the device or remote. Long press and to fine tune the frequencies. The display panel shows the frequency. During power on, the last played FM channel starts playing.
- Press to select the previous channel or to select the next channel.
- To play a specific frequency, enter the number from the device or remote. For example, when you enter 1023, the 102.3 MHz frequency will be played. Any number entered outside FM frequency band will be ignored.
- To store a specific frequency as preset channel (favorite):
 - Enter three or four digits of the frequency from the device or remote. For example, when you enter 1023, the display will show 102.3 MHz.
 - Press the store button .
 - Enter a number from 1 to 30 in which the radio channel is going to be saved as a favorite. Any number outside this range will be ignored.
 - Press the store button again .
- Press RDS (Radio Data System) to enable the functions of the radio data system:

- PS: program service name.
- CT: clock time and date.
- Press and hold the RDS key for more than two seconds to exit the RDS function.

4.2 USB or SD

The USB or SD interface supports MP3 audio files stored on a USB flash memory device or an SD card up to 32 GB of exFAT or FAT32 file system.

The USB interface supports USB 2.0 — USB 3.1 flash drives.

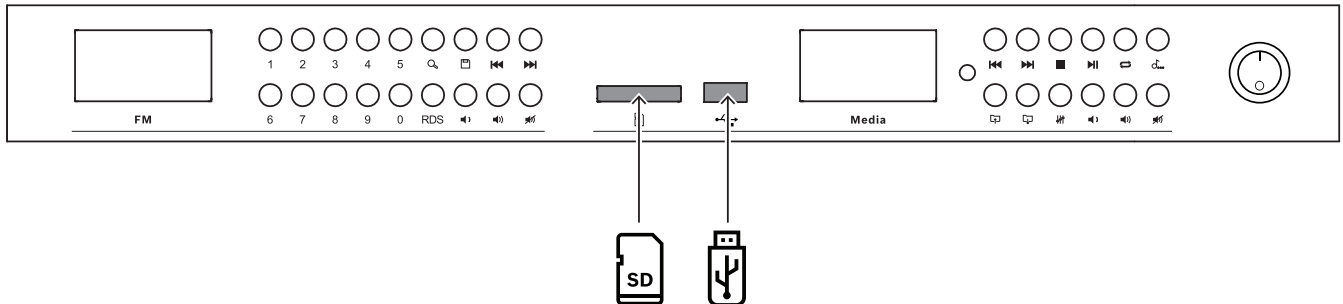

Operation

- Insert an SD card or an USB flash memory device.
- Select the source, USB device or SD, with the key of the device or from the remote.
- Press to play the track.
 - The LCD lower line will show, from left to right:
Track number (maximum 8000 tracks), mm:ss (track duration).
 - If ID3 tags of the MP3 file are available, the following additional information will be scrolling on the display. If the ID3 tags are not available, the filename will be displayed instead:
File - < name >, Track - < name >, Artist - < name >, Album - < name >
- Press to toggle between play or pause.
 - In pause mode, the pause symbol (||) and the track playing time elapsed will be shown.
- Press to select the previous track or to select the next.
- Press to stop.

To play a list of tracks:

- Organize the files in the folder.
- Browse to the folder.
- Press play.
- To repeat a track or list of songs, press . This button toggles as follows:
 - 1st press: Current track will always be repeated (display shows: ONE).
 - 2nd press: All tracks will be played once (display shows: ALL).
 - 3rd press: All tracks will be repeated in loop in random sequence (display shows: RND).
 - 4th press: All tracks will be repeated in sequence (display shows: SEQ).
 - 5th press: All tracks of the present folder will be played (display shows: FLD).

The sequence is repeated with the 6th press.

- For tone control, press .

This button toggles as follows:

 - 1st press: Equalizer, Δ and ∇ to choose between Normal, Pop, Rock, Jazz, Classic.
 - 2nd press: Bass, adjust the bass with Δ and ∇ .
 - 3rd press: Treble, adjust the treble with Δ and ∇ .
 - 4th press: Balance, adjust the balance with Δ and ∇ .
 - 5th press: Loudness, switch on or off the loudness with Δ and ∇ .

The sequence is repeated with the 6th press.

The selected option appears on the display.





4.3 Bluetooth®

PRM-USTB has a Bluetooth® receiver that can be paired with a Bluetooth®-enabled music source like a mobile phone, tablet, or computer.

Pair a device

1. Select the source of the PRM-USTB as Bluetooth®.
If the device is already paired, the display will show **Paired**.
2. Enable Bluetooth® on your device (mobile phone, tablet, or computer).
3. Select **Bosch PRM-USTB** from the list of discovered products.
The display on the PRM-USTB shows **Pairing**.
4. If the pairing is successful, the PRM-USTB display shows **Paired**.

Operation

- Press  to play the track.
- Press  to toggle between play or pause.
- Press  to select the previous track or  to select the next.
- For tone control, press .

This button toggles as follows:

 - 1st press: Equalization, Δ and ∇ to choose between Normal, Pop, Rock, Jazz, Classic.
 - 2nd press: Bass, adjust the bass with Δ and ∇ .
 - 3rd press: Treble, adjust the treble with Δ and ∇ .
 - 4th press: Balance, adjust the balance with Δ and ∇ .
 - 5th press: Loudness, switch on or off the loudness with Δ and ∇ .

The sequence is repeated with the 6th press.

The selected option appears on the display.

5 Troubleshooting

Problem	Possible cause	Possible solution
The unit does not work.	Power (plug) disconnected, the unit is switched off or the mains fuse is broken.	Insert power cord and switch on the unit. Check the mains fuse.
USB or SD storage device not detected.	Device does not comply with USB mass storage.	Use a device complying with the class of USB mass storage (some portable audio players included in the class of image devices are not supported. Also, some flash card readers cannot be detected)
	USB hub in use.	Some USB hubs will not operate properly. Try a different USB hub, or connect the storage device directly to the USB port. Also, if multiple devices for USB storage are connected through a USB hub, only one of the devices will be recognized.
	Format not supported.	Use only FAT, FAT32 and exFAT file structure.
	The connection with the unit has been terminated because an electrical current higher than allowed was taken from unit's USB socket.	Wait several minutes. The rating (allowable current) for this unit is 500 mA or less per USB port. Use USB storage devices that meet these standards. If you have a USB storage device connected through a buspowered USB hub, connect the USB storage device directly to this unit port. If shorted a long time the USB port will become defective.
	Partitioning of SD card is wrong. Apart from SD, SDHC and class of SD cards, it is also possible that the card has a different partition table than expected.	Reformat the USB or SD card with a PC that is known to give good results.
MP3 tracks do not play.	Format not supported.	MP3s are supported up to 320 kbps.
	Media is in "Stop" or "Pause" mode.	Change the mode to "Play".

Problem	Possible cause	Possible solution
No audio output.	The audio output cable has come loose or has not been properly plugged in.	Plug in audio cable properly.
	The audio output is muted.	Adjust the volume setting for tuner or media player.
	The audio output connectors or plugs are dirty.	Wipe away dust or dirt and reinsert the plug.
	The selected source is currently in pause or mute mode.	Press the play button or the mute button.
The audio output is distorted or full of noise.	The audio output cable has not been properly plugged in.	Connect the audio cable to one of the three stereo RCA output connectors.
	Connectors or plugs are dirty.	Wipe away dust or dirt and reinsert the plug.

6 Technical data

Electrical

Mains power supply	
Voltage range	110 — 120 VAC +/-10 %, 50 — 60 Hz 220 — 240 VAC +/-10 %, 50 — 60 Hz
Power supply fuse	0.63 A / 250 V
Power consumption	15 W max.
FM tuner	
FM frequency range	87.5 — 108 MHz
Frequency response	50 Hz — 12 kHz +/-3 dB
Channel separation (1 kHz)	> 25 dB
Signal-to-noise ratio	> 50 dB
FM input sensitivity	26 dBu
Antenna impedance	75 ohm
Audio output level	1.5 V rms +/- 1dB at 10 kΩ
USB or SD source	
Frequency response	50 Hz — 18 kHz +/-1 dB
Signal-to-noise ratio (1 kHz)	> 75 dB
Total harmonic distortion (1 kHz)	< 0.5 %
Channel separation (1 kHz)	> 70 dB
Audio output level	1.5 V rms +/-1 dB at 10 kΩ
USB output current limit	500 mA
Maximum memory size of USB and SD card	32 GB maximum
Supported file structure	FAT, FAT32 and exFAT
Supported audio files	mp3, wma, wav, flac, ape, m4a

Bluetooth®

Version	Bluetooth® 5.0
Distance	>5 m
Supported profiles	A2DP, AVRCP
Frequency response (Hz)	50 Hz — 18 kHz +/- 1 dB
Signal-to-noise ratio (1 kHz)	>75 dB
Total harmonic distortion (1 kHz)	<0.5%
Channel separation (1 kHz)	>70 dB
Audio output level	1.5 V rms +/- 1 dB at 10 kΩ

Mechanical

Unit dimensions (H x W x D)	
With brackets:	44 x 482 x 250 mm (1.73 x 18.98 x 9.84 in)
Without brackets:	44 x 430 x 250 mm (1.73 x 16.93 x 9.84 in)
Unit mounting	Stand-alone, 19" rack (19" wide, 1 U high)
Unit color	Black RAL 9017
Unit weight	3.20 kg
Remote control dimensions (L x W x D)	130 x 44 x 20 mm (5.23 x 1.73 x 0.79 in)
Remote control weight: (without batteries)	32 g

Environmental

Operating temperature	0 °C — 45 °C
Storage temperature	-40 °C — 70 °C
Relative humidity (non-condensing)	<90%

Bosch Security Systems B.V.

Torenallee 49

5617 BA Eindhoven

Netherlands

www.boschsecurity.com

© Bosch Security Systems B.V., 2022

Building solutions for a better life.

202207011039