



EPS

OUTDOOR

Compact, high-power speakers
for outdoor installations



Cruise Ships



Theme Parks



Rooftop Bars



Beach Bars



Public Spaces



Outdoor Clubs

Great sound for the great outdoors

Building on the platform of NEXO's industry-standard PS Series point source loudspeakers, the ePS Series provides a 'no frills' loudspeaker range that makes legendary NEXO engineering and performance accessible to a wider range of projects.

Now comes ePS Outdoor, a range of 4 weatherproof loudspeakers engineered and tested for use in outdoor installations. ePS Outdoor delivers NEXO's trademark musical, high output, full range sound, with all the versatility that comes with precision coverage, variable HF directivity and a small but flexible range of universal mounting hardware.

Four lightweight point source cabinets partner high-excursion 6, 8, 10 and 12-inch LF drivers respectively with a 1.4" diaphragm HF driver (ePS12/1.7").

An extensive range of cabinet fittings are provided for mounting and rigging hardware. Two M6 with 80mm pitch and one M10 fitting on the cabinet sides allow connection to U Bracket, bumper or eye bolts. The back of each speaker is fitted with 3x M6 with 70mm pitch for wall-mount in both horizontal and vertical positions.

Rigorously tested for extreme conditions

Robust and light in weight, IP55-rated ePS loudspeakers feature a 15mm birch shell protected by a high-grade polyurethane coating.

In addition to EN54-24 certification, ePS Outdoor loudspeakers have been further developed and tested to ensure consistent performance and long product life, even in the most severe conditions. From the use of high-grade A4 stainless-steel screws to UV-protected front cloth and polyurethane coating, every detail has been considered and the final designs have been subjected to 800 hours of salt spray testing (ISO 9227 standard) and 600 hours UV testing (DIN 75220 standard).



Ready for every environment

Connections on the rear of the speakers are made through two (in/out) pairs of terminal blocks, while the included IP cover protects the connectors from moisture in outdoor applications.

Four Speakers. One Voice.



ePs6-EN54

Measuring 365mm high x 198mm wide x 181mm deep and weighing 7.1Kg, the ePs6-EN54 combines a high excursion 6-inch LF driver with a 1.4-inch diaphragm HF driver in a trapezoidal cabinet constructed in a closed acoustic design from 15mm Baltic birch plywood. Achieving a peak SPL of 125dB with a frequency range of 90Hz to 20kHz, the ePs6-EN54 features a rotatable asymmetric horn, convenient rigging points on the cabinet top, bottom and back, and two pairs of In/Out connectors on pitch screw terminal blocks with an IP cover.



125dB Peak SPL

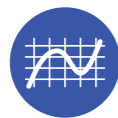

90Hz to 20kHz
Frequency Response



6-inch LF Driver



ePs8-EN54

Measuring 423mm high x 250mm wide x 227mm deep and weighing 8.1Kg, the ePs8-EN54 combines a high excursion 8-inch LF driver with a 1.4-inch diaphragm HF driver in a trapezoidal cabinet constructed in a bass-reflex design from 15mm Baltic birch plywood. Achieving a peak SPL of 128dB with a frequency range of 80Hz to 20kHz, the ePs8-EN54 features a rotatable asymmetric horn, convenient rigging points on the cabinet top, bottom and back, and two pairs of In/Out connectors on pitch screw terminal blocks with an IP cover.



128dB Peak SPL

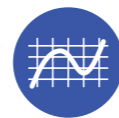

80Hz to 20kHz
Frequency Response



8-inch LF Driver



ePs10-EN54

Measuring 531mm high x 316mm wide x 285mm deep and weighing 14.8Kg, the ePs10-EN54 combines a high excursion 10-inch LF driver with a 1.4-inch diaphragm HF driver in a trapezoidal cabinet constructed in a bass-reflex design from 15mm Baltic birch plywood. Achieving a peak SPL of 130dB with a frequency range of 70Hz to 20kHz, the ePs10-EN54 features a rotatable asymmetric horn, convenient rigging points on the cabinet top, bottom and back, and two pairs of In/Out connectors on pitch screw terminal blocks with an IP cover.



130dB Peak SPL

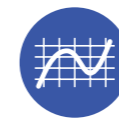

70Hz to 20kHz
Frequency Response



10-inch LF Driver



ePs12-EN54

Measuring 600mm high x 370mm wide x 317mm deep and weighing 18Kg, the ePs12-EN54 combines a high excursion 12-inch LF driver with a 1.7-inch diaphragm HF driver in a trapezoidal cabinet constructed in a bass-reflex design from 15mm Baltic birch plywood. Achieving a peak SPL of 133dB with a frequency range of 60Hz to 20kHz, the ePs12-EN54 features a rotatable asymmetric horn, convenient rigging points on the cabinet top, bottom and back, and two pairs of In/Out connectors on pitch screw terminal blocks with an IP cover.



133dB Peak SPL

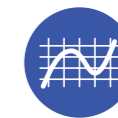

60Hz to 20kHz
Frequency Response



12-inch LF Driver



Waterproof.
Dustproof.
UV-Proof.

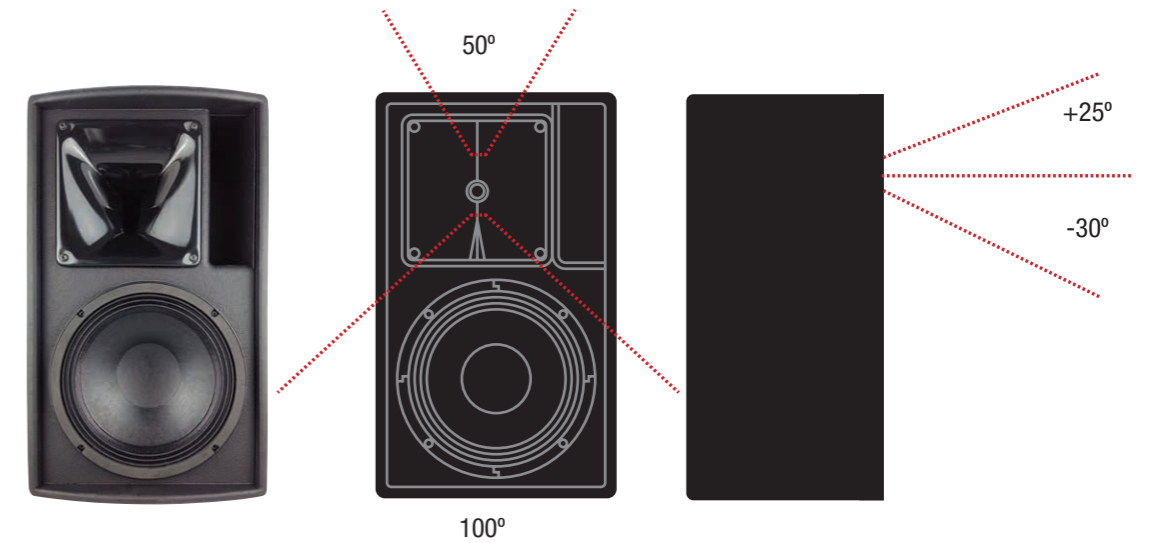

Variable HF directivity for perfect coverage

A satisfactory audience experience often necessitates compromise between the wide, short throw coverage required by listeners closest to the speaker, and the narrow, long throw coverage required by those furthest away. The asymmetrical horns in ePS speakers are engineered such that vertical coverage is narrower above horn axis than below. The horn can be rotated to ensure optimum directivity for every installation.



Custom Colours

Custom RAL colours are available, but not in the waterproof paint formulation of the standard black-finished cabinets.

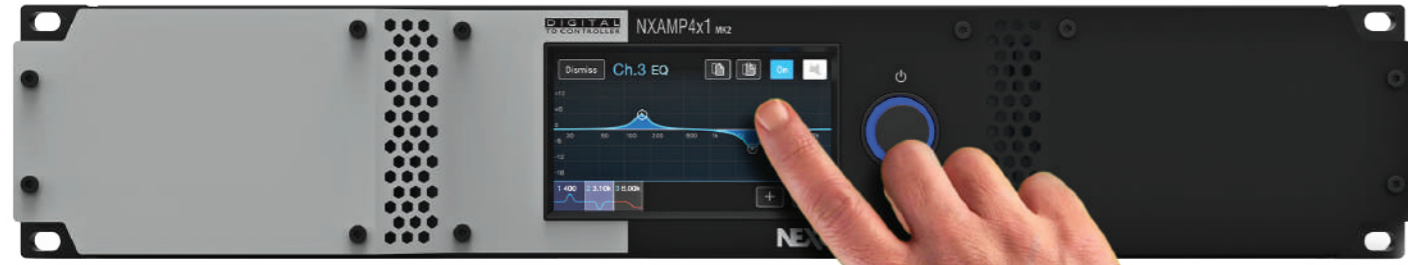

Power & Processing

NXAMP MK2

With models rated at 4 x 1300 Watts, 4 x 2500 Watts and 4 x 4500 watts, NXAMP MK2 combines advanced signal processing with four state-of-the-art Class D amplifiers to create a flexible, light-weight powering and control solution that's perfect for use with NEXO ePS installations. Easy to set up and quick to deploy, all essential parameters are readily accessible via a large colour touchscreen on the front panel, with a comprehensive range of control and networking facilities on the rear panel. 96KHz converters and 64-bit signal processing combine to assure pristine sound quality.

- Class D
- P/F/C
- Ether
Sound
- Dante
- NeMo
- AES/EBU
- 4.3" display
- Tactile screen
- Dual Ethernet Port
* Optional



DTD

The DTD delivers advanced speaker control processing taken from the NEXO NXAMP in a compact, rack-mounting device. Providing sophisticated control over crossover, EQ and time-alignment along with speaker protection, the DTD is very easy to use, with high-end AD and DA converters and 64-bit/96kHz processing ensuring an analog in-to-analog-out dynamic range greater than 112dB, with distortion kept to under 0.001%. Presets are included for all ePS speakers, along with other speakers in the NEXO range.

Accessories

ePS Outdoor cabinets can be fitted with a range of NEXO and universal mounting hardware for horizontal and vertical installation.

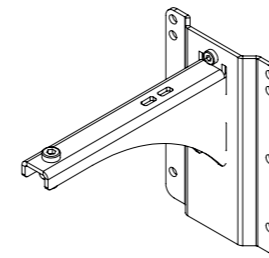

Wall mounting bracket
VNI-WM200
VNI-WM280
VNI-WM330

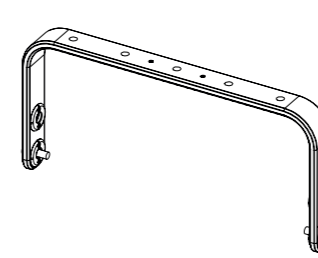

Horizontal mounting bracket
VNU-HBRK365 bracket for ePS6-EN54
VNU-HBRK425 bracket for ePS8-EN54
VNU-HBRK535 bracket for ePS10-EN54
VNU-HBRK600 bracket for ePS12-EN54

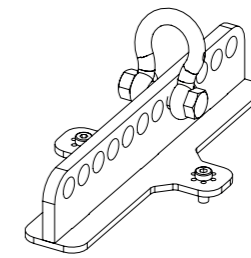

Bumper mount
VNU-BUMP

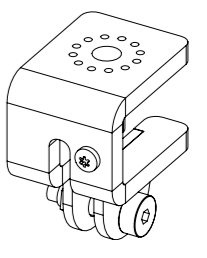

Wall mount adapter
VNI-WMADAPT

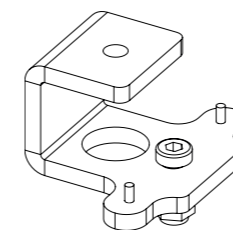

Ceiling mount
VNI-CLADAPT

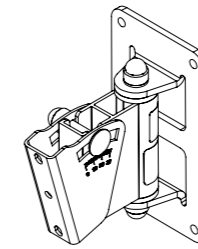

Variable angle wall mount
VNI-WM01
VNI-WM01-OU
VNI-WM02
VNI-WM02-OU

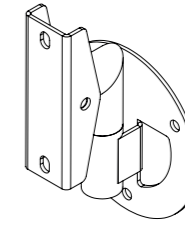

Light weight wall mount
VNI-WB02



Create sophisticated audio systems that anyone can operate

ProVisionaire is a suite of software applications for the design, operation, and management of sound systems built around Yamaha Pro Audio products and NEXO NXAMP MK2 Powered Controllers. Fully-customisable ProVisionaire software lets users create complex, fully-scalable audio systems - from the smallest to the largest - using just one software suite. What's more, it delivers the ability for them to be operated very easily by anyone - from the most knowledgeable audio engineer to the most inexperienced user - using a tablet, laptop or desktop computer.

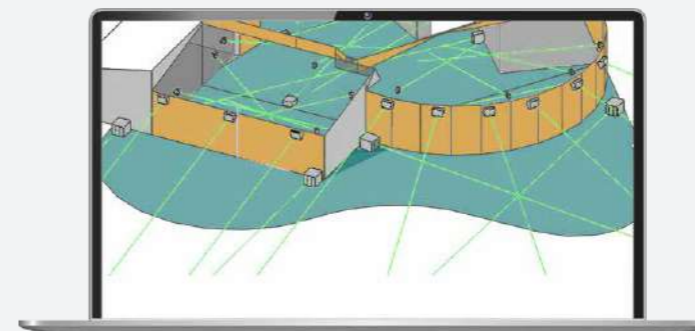

NS-1

Perfect coverage made easy.

NEXO is able to provide full sound system design support, offering our extensive experience and powerful modelling tools to augment the resources of consultancies and integrators, or even to provide complete venue designs on their behalf.

At the heart of our design process is NS-1, NEXO's powerful system configuration and simulation tool which ensures uniform SPL coverage of any NEXO system in any venue.

Specifications

	ePS6-EN54	ePS8-EN54	ePS10-EN54	ePS12-EN54
WITH NEXO PROCESSING				
Frequency Response @-6 dB	90 Hz to 20 kHz	80 Hz to 20 kHz	70 Hz to 20 kHz	60 Hz to 20 kHz
Sensitivity 1W@1m	98 dB SPL Nominal	100 dB SPL Nominal	101 dB SPL Nominal	103 dB SPL Nominal
Peak SPL@1m	125 dB	128 dB	130 dB	133 dB
Vertical Dispersion	+25°/-30°			
Horizontal Dispersion	50° to 100° Asymmetrical			
Crossover Frequency	90 Hz, 120 Hz	80 Hz, 120 Hz	70 Hz, 120 Hz	60 Hz, 85 Hz 120 Hz
Nominal Impedance	8 Ω			
Recommended Power	310 to 490 Watts / 8 Ohms	350 to 570 Watts / 8 Ohms	500 to 800 Watts / 8 Ohms	600 to 950 Watts / 8 Ohms
PRODUCT FEATURES				
Number of ways	2 ways passive			
LF Component	6" 8 Ohms long excursion driver	8" 8 Ohms long excursion neodymium driver	10" 8 Ohms long excursion neodymium driver	12" 8 Ohms long excursion neodymium driver
HF Component	1.4" diaphragm 8 Ohms HF driver on an Asymmetrical Dispersion ("PS") horn			1.7" diaphragm 8 Ohms HF driver on an Asymmetrical Dispersion ("PS") horn
Connectors	2 pairs (In/Out) of 5 mm pitch Push-in Cage Clamp terminal blocks (+/- poles)			
Compatible cables section	Cables from 0.2 mm ² to 4 mm ² (AWG 24 to 12) copper section			
Compatible cables outside diameter	Cable with maximum outside diameter of 11 mm			
Rigging points	3x M6 - 70 mm pitch rigging points (back) + 2x extra M6 and 1x M10 (top/bot)			
Material	15 mm thick birch plywood body with polyurethane coating and galvanized grill			
Finish	Black structural paint (RAL9005 or Custom RAL upon request)			
Front Finish	Galvanized grill in front of UV & Fire resistant acoustic fabric			
Height x Width x Depth	365mm x 198mm x 181mm (14.4" x 7.8" x 7.1")	423mm x 250mm x 227mm (16.7" x 9.8" x 8.9")	531mm x 316mm x 285mm (20.9" x 12.4" x 11.2")	600mm x 370mm x 317mm (23.6" x 14.6" x 12.5")
Weight: Net	7.1 kg (15.7 lbs)	8.1 kg (17.9 lbs)	14.8 kg (32.6 lbs)	18 kg (40 lbs)
Operating temperature range	0°C - 40 °C (32° F - 104° F)			
Storage temperature range	-20 °C - 60 °C (-4 ° F - 140° F)			
IP Rating	IP55			
SYSTEM OPERATION				
Recommended powering solution	NXAMP4x1mk2 Powered TDcontroller: Up to 4 x ePS6-EN54 per channel	NXAMP4x1mk2 Powered TDcontroller: Up to 3 x ePS8-EN54 per channel	NXAMP4x1mk2 Powered TDcontroller: 1 x ePS10-EN54 per channel	NXAMP4x1mk2 Powered TDcontroller: 1 x ePS12-EN54 per channel
Optional powering solution	NXAMP4x2mk2 Powered TDcontroller: Up to 4 x ePS6-EN54 per channel NXAMP4x4mk2 Powered TDcontroller: Up to 4 x ePS6-EN54 per channel	NXAMP4x2mk2 Powered TDcontroller: Up to 4 x ePS8-EN54 per channel NXAMP4x4mk2 Powered TDcontroller: Up to 4 x ePS8-EN54 per channel	NXAMP4x2mk2 Powered TDcontroller: Up to 4 x ePS10-EN54 per channel NXAMP4x4mk2 Powered TDcontroller: Up to 4 x ePS10-EN54 per channel	NXAMP4x2mk2 Powered TDcontroller: Up to 4 x ePS12-EN54 per channel NXAMP4x4mk2 Powered TDcontroller: Up to 4 x ePS12-EN54 per channel
EN54-24 SYSTEM SPECIFICATIONS				
Nominal Impedance	5 Ohms		4 Ohms	3 Ohms
Nominal Continuous Voltage	22 Vms	29 Vms	32 Vms	35 Vms
Nominal Continuous Power	100 Watts	170 Watts	250 Watts	400 Watts
Sensitivity 1W@4m	74 dB SPL	77 dB SPL		78 dB SPL
Max Continuous Sound Pressure @4m	94 dB SPL	99 dB SPL	101 dB SPL	104 dB SPL

*Dimensions are within a tolerance of -0 +3 mm



NEXO
Parc d'Activité
du Pré de la Dame Jeanne
B.P.5
60128 Plailly
FRANCE
Tel: +33 (0)3 44 99 00 70
Fax: +33 (0)3 44 99 00 30
E-mail: info@nexo.fr

