

USER'S MANUAL
BEDIENUNGSANLEITUNG
MANUEL D'UTILISATION
MANUAL DE USUARIO
INSTRUKCJA OBSŁUGI
MANUALE D'USO

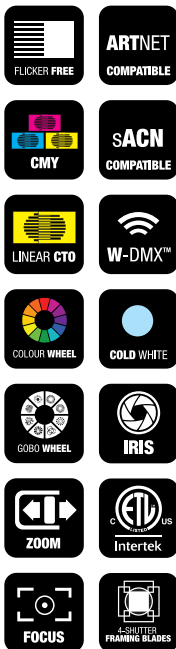

OPUS SP5

PROFILE MOVING HEAD
CLOSP5P

CONTENTS / INHALTSVERZEICHNIS / CONTENU / CONTENIDO / TREŚĆ / CONTENUTO

ENGLISH

PREVENTIVE MEASURES	3
INTRODUCTION	5
CONNECTIONS, CONTROL AND DISPLAY ELEMENTS OPERATION	5
CONTROL MENU (CONTROL)	7
SYSTEM SETTINGS (SETTINGS)	8
SERVICE MENU	11
DEVICE INFO (INFO)	12
SETUP AND INSTALLATION	13
DMX TECHNOLOGY	14
TECHNICAL SPECIFICATIONS	14
MANUFACTURER'S DECLARATIONS	15
DMX CONTROL	16
	90

DEUTSCH

SICHERHEITSHINWEISE	17
EINFÜHRUNG	19
ANSCHLÜSSE, BEDIEN- UND ANZEIGEELEMENTE BEDIENUNG	19
KONTROLLMENÜ (CONTROL)	21
SYSTEMEINSTELLUNGEN (SETTINGS)	22
SERVICEMENÜ	25
GERÄTEINFORMATIONEN (INFO)	26
AUFSTELLUNG UND MONTAGE	27
DMX TECHNIK	28
TECHNISCHE DATEN	28
HERSTELLERERKLÄRUNGEN	29
DMX STEUERUNG	30
	90

FRANCAIS

MESURES PRÉVENTIVES	31
INTRODUCTION	33
RACCORDEMENTS, ÉLÉMENTS DE COMMANDE ET D'AFFICHAGE	33
COMMANDE	35
PANNEAU DE COMMANDE (CONTROL)	36
PARAMÈTRES DU SYSTÈME (SETTINGS)	39
MENU DE SERVICE	41
INFORMATIONS DE L'APPAREIL (INFO)	41
INSTALLATION ET MONTAGE	42
TECHNOLOGIE DMX	44
CARACTÉRISTIQUES TECHNIQUES	44
DÉCLARATIONS DU FABRICANT	45
PILOTAGE EN MODE DMX	90

ESPAÑOL

MEDIDAS DE SEGURIDAD	46
INTRODUCCIÓN	48
CONEXIONES, ELEMENTOS DE MANEJO Y ELEMENTOS DE VISUALIZACIÓN	48
MANEJO	50
MENÚ DE CONTROL (CONTROL)	51
CONFIGURACIÓN DEL SISTEMA (SETTINGS)	54
MENÚ DE SERVICIO	56
INFORMACIÓN DEL EQUIPO (INFO)	56
INSTALACIÓN Y MONTAJE	57
TECNOLOGÍA DMX	57
DATOS TÉCNICOS	58
DECLARACIONES DEL FABRICANTE	60
CONTROL DMX	90

POLSKI

ŚRODKI OSTROŻNOŚCI	61
WPROWADZENIE	63
GNIAZDA, ELEMENTY OBSŁUGI I WSKAŹNIKI OBSŁUGA	63
MENU STEROWANIA (CONTROL)	65
USTAWIENIA SYSTEMU (SETTINGS)	66
MENU SERWISOWE	69
INFORMACJE O URZĄDZENIU (INFO)	70
USTAWIANIE I MONTAŻ	71
TECHNIKA DMX	72
DANE TECHNICZNE	72
OŚWIADCZENIA PRODUCENTA	73
STEROWANIE DMX	75
	90

ITALIANO

MISURE PRECAUZIONALI	76
INTRODUZIONE	78
CONNETTORI, ELEMENTI DI COMANDO E VISUALIZZAZIONE	78
UTILIZZO	80
MENU CONTROLLO (CONTROL)	81
IMPOSTAZIONI DI SISTEMA (SETTINGS)	84
MENU ASSISTENZA (SERVICE)	85
INFORMAZIONI SUL DISPOSITIVO (INFO)	86
INSTALLAZIONE E MONTAGGIO	87
TECNOLOGIA DMX	87
DATI TECNICI	88
DICHIARAZIONI DEL PRODUTTORE	89
CONTROLLO DMX	90

YOU'VE MADE THE RIGHT CHOICE!

We have designed this product to operate reliably over many years. Please read this User's Manual carefully, so that you can begin making optimum use of your Cameo Light product quickly. Learn more about Cameo Light on our website WWW.CAMEOLIGHT.COM.

PREVENTIVE MEASURES

1. Please read these instructions carefully.
2. Keep all information and instructions in a safe place.
3. Follow the instructions.
4. Observe all safety warnings. Never remove safety warnings or other information from the equipment.
5. Use the equipment only in the intended manner and for the intended purpose.
6. Use only sufficiently stable and compatible stands and/or mounts (for fixed installations). Make certain that wall mounts are properly installed and secured. Make certain that the equipment is installed securely and cannot fall down.
7. During installation, observe the applicable safety regulations for your country.
8. Never install and operate the equipment near radiators, heat registers, ovens or other sources of heat. Make certain that the equipment is always installed so that it is cooled sufficiently and cannot overheat.
9. Never place sources of ignition, e.g., burning candles, on the equipment.
10. Ventilation slits must not be blocked.
11. This appliance is designed exclusively for indoor use, do not use this equipment in the immediate vicinity of water (does not apply to special outdoor equipment - in this case, observe the special instructions noted below). Do not expose this equipment to flammable materials, fluids or gases.
12. Make certain that dripping or splashed water cannot enter the equipment. Do not place containers filled with liquids, such as vases or drinking vessels, on the equipment.
13. Make certain that objects cannot fall into the device.
14. Use this equipment only with the accessories recommended and intended by the manufacturer.
15. Do not open or modify this equipment.
16. After connecting the equipment, check all cables in order to prevent damage or accidents, e.g., due to tripping hazards.
17. During transport, make certain that the equipment cannot fall down and possibly cause property damage and personal injuries.
18. If your equipment is no longer functioning properly, if fluids or objects have gotten inside the equipment or if it has been damaged in another way, switch it off immediately and unplug it from the mains outlet (if it is a powered device). This equipment may only be repaired by authorized, qualified personnel.
19. Clean the equipment using a dry cloth.
20. Comply with all applicable disposal laws in your country. During disposal of packaging, please separate plastic and paper/cardboard.
21. Plastic bags must be kept out of reach of children.

FOR EQUIPMENT THAT CONNECTS TO THE POWER MAINS:

22. CAUTION: If the power cord of the device is equipped with an earthing contact, then it must be connected to an outlet with a protective ground. Never deactivate the protective ground of a power cord.
23. If the equipment has been exposed to strong fluctuations in temperature (for example, after transport), do not switch it on immediately. Moisture and condensation could damage the equipment. Do not switch on the equipment until it has reached room temperature.
24. Before connecting the equipment to the power outlet, first verify that the mains voltage and frequency match the values specified on the equipment. If the equipment has a voltage selection switch, connect the equipment to the power outlet only if the equipment values and the mains power values match. If the included power cord or power adapter does not fit in your wall outlet, contact your electrician.
25. Do not step on the power cord. Make certain that the power cable does not become kinked, especially at the mains outlet and/or power adapter and the equipment connector.
26. When connecting the equipment, make certain that the power cord or power adapter is always freely accessible. Always disconnect the equipment from the power supply if the equipment is not in use or if you want to clean the equipment. Always unplug the power cord and power adapter from the power outlet at the plug or adapter and not by pulling on the cord. Never touch the power cord and power adapter with wet hands.
27. Whenever possible, avoid switching the equipment on and off in quick succession because otherwise this can shorten the useful life of the equipment.
28. IMPORTANT INFORMATION: Replace fuses only with fuses of the same type and rating. If a fuse blows repeatedly, please contact an authorised service centre.
29. To disconnect the equipment from the power mains completely, unplug the power cord or power adapter from the power outlet.
30. If your device is equipped with a Volex power connector, the mating Volex equipment connector must be unlocked before it can be removed. However, this also means that the equipment can slide and fall down if the power cable is pulled, which can lead to personal injuries and/or other damage. For this reason, always be careful when laying cables.
31. Unplug the power cord and power adapter from the power outlet if there is a risk of a lightning strike or before extended periods of disuse.
32. The device must only be installed in a voltage-free condition (disconnect the mains plug from the mains).
33. Dust and other debris inside the unit may cause damage. The unit should be regularly serviced or cleaned (no guarantee) depending on ambient conditions (dust etc., nicotine, fog) by qualified personnel to prevent overheating and malfunction.
34. Please keep a distance of at least 0.5 m to any combustible materials.
35. Power cables to power multiple devices must have a cross-section of at least 1.5 mm². Within the EU, the cables must correspond to H05VV-F, or similar. Suitable cables are offered by Adam Hall. With these cables, you can connect multiple devices via the power OUT connection to the power IN connection of an additional device. Make sure that the total current consumption of all connected devices does not exceed the specified value on all connected devices (label on the device). Make sure to keep power cable connections as short as possible.

**CAUTION:**

To reduce the risk of electric shock, do not remove cover (or back). There are no user serviceable parts inside. Maintenance and repairs should be exclusively carried out by qualified service personnel.



The warning triangle with lightning symbol indicates dangerous uninsulated voltage inside the unit, which may cause an electrical shock.



The warning triangle with exclamation mark indicates important operating and maintenance instructions.



Warning! This symbol indicates a hot surface. Certain parts of the housing can become hot during operation. After use, wait for a cool-down period of at least 10 minutes before handling or transporting the device.



Warning! This device is designed for use below 2000 metres in altitude.



Warning! This product is not intended for use in tropical climates.



Caution! Intense LED light source! Risk of eye damage. Do not look into the light source.

CAUTION! IMPORTANT INFORMATION ABOUT LIGHTING PRODUCTS!

1. The product has been developed for professional use in the field of event technology and is not suitable as household lighting.
2. Do not stare, even temporarily, directly into the light beam.
3. Do not look at the beam directly with optical instruments such as magnifiers.
4. Stroboscope effects may cause epileptic seizures in sensitive people! People with epilepsy should definitely avoid places where strobes are used.

INTRODUCTION

MOVING HEAD OPUS SERIES

CLOSP5P (Profiler)

CONTROL FUNCTIONS

34-channel and 50-channel DMX control (SP5P)

27-channel and 33-channel DMX control (SP5 with optional CLOSP5AM animation wheel module)

Art-Net

sACN

W-DMX™

RDM enabled

Master / slave mode

Stand-alone functions

PROPERTIES

500W LED. Framing shutter module. CMY + CTO color mixture. Color wheel with 7 brilliant colors + open and split colors. Gobo wheel 1 with 8 fixed gobos + open. Gobo wheel 2 with 7 rotating gobos + open (gobos interchangeable). 2 rotating prisms. Focusing and zoom function via DMX. Frost filter and iris. Stroboscopic. Pan and tilt motors with 16 bit resolution. Battery-powered display for configuration when not connected to power. Automatic position correction. Temperature-controlled fans. 3- and 5-pin DMX connector. RJ45 network connector. Wireless DMX™. Neutrik powerCON TRUE1 mains connector, IN and OUT. 2 omega mounting brackets included. Operating voltage: 100-240V AC. Power consumption: 800W.

The spotlight has the RDM standard (Remote Device Management). This device manager allows the user to request the status of and configure RDM end devices via an RDM-capable controller.

ADDITIONAL FEATURES

The CLOSP5P moving head is equipped and delivered with a 4-plane framing shutter module. The 4-plane framing shutter module can be replaced with the optional CLOSP5AM animation wheel module. The device software and corresponding DMX modes will adjust automatically.

CONNECTIONS, CONTROL AND DISPLAY ELEMENTS

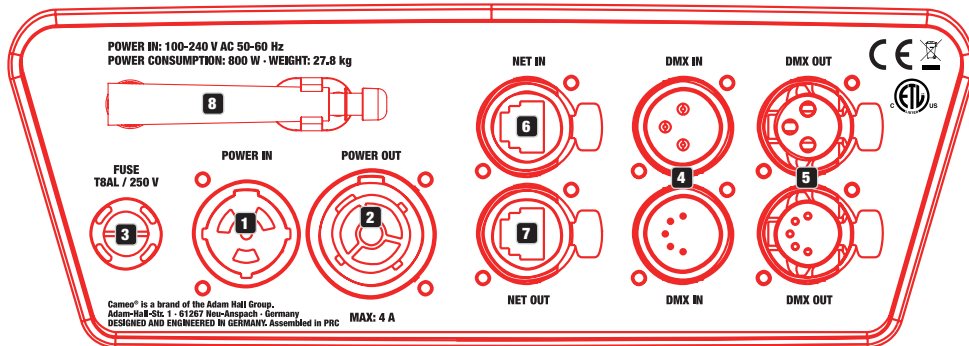

1 POWER IN

Neutrik powerCON TRUE1 mains input socket. Operating voltage: 100 - 240V AC / 50 - 60Hz. A suitable power cable with powerCON TRUE1 plug is included in delivery.

2 POWER OUT

Neutrik powerCON TRUE1 mains output socket. Serves to provide power to additional CAMEO spotlights. Ensure that the total power consumption of all devices connected to the device does not exceed the given Ampere (A) value.

3 FUSE

Fuse holder for 5 x 20 mm micro fuses. **IMPORTANT INFO:** Replace the fuse only with a fuse of the same type and values. If a fuse trips repeatedly, please contact an authorized service center.

4 DMX IN

Male 3- and 5-pin XLR connector to connect a DMX control device (e.g. DMX console).

5 DMX OUT

Female 3- and 5-pin XLR connector to transmit the DMX control signal.

6 NET IN

RJ45 network connector to connect with an Art-Net or sACN network. When setting up the network, use cables of category CAT-5e or better.

7 NET OUT

RJ45 network connector to connect additional Art-Net-capable or sACN-capable devices with a network. When setting up the network, use cables of category CAT-5e or better.

8 ANTENNA FOR W-DMX™

The antenna for W-DMX™ control remains in its holder during operation (= operating position).

**9 PRESSURE-SENSITIVE LC-DISPLAY WITH BACKLIGHTING**

Thanks to the pressure-sensitive LC display, the device can be operated directly from the display (can be used with gloves). The display shows the currently active operating mode (main display), the menu options in the Options menu, and the numerical values or operating status for certain menu options. If there is no control signal to the device, the display will begin to flash. This flashing will stop as soon as a control signal is received (DMX and Slave mode, ArtNet and sACN).

10 TOUCH-SENSITIVE CONTROL FIELDS

MODE - Press **MODE** (repeatedly) to go one level higher in the menu structure to the main display.

UP ▲ and **DOWN ▼** - Selects the individual menu options in the main menu (DMX address, operating mode, etc.) and in the submenus.

ENTER - Starting from the main display, press **ENTER** to go to the main menu. In the main menu, press **ENTER** to access the menu level where you can change values. You can also confirm value adjustments by pressing **ENTER**.

LEFT ◀ and **RIGHT ▶** - Use these buttons to change the value, for instance the DMX address, as desired.

11 USB INTERFACE

USB interface to update the device firmware. In the **Service menu**, set **USB Update** to **ON**. Download, when available, the current firmware from the product page at www.cameolight.com, unzip it, and copy the files to a folder without any special characters on a USB stick. Disconnect the moving head from the power and all input connections (DMX / Ethernet), connect the USB stick via the USB port, and then reconnect the moving head to the power. The USB stick will be automatically detected and shown on the display. Now navigate to the corresponding folder on the USB stick and confirm this via "ON". The update process will begin. Do not remove the USB stick or disconnect the moving head from the power during the update process.

The battery-powered display can be activated even if the device is not connected to the power. To do so, press and hold MODE for a period of 12 seconds. You can now view device information and change and save system settings, even if the device is not connected to the power. The external control of the spotlight will not activate in this case. This means that the display will show that there is no control signal present, even if there is one present for the device.



12 PAN LOCK

Mechanical locking mechanism to prevent the head from turning in a horizontal direction during transport. Disconnect the device from the mains power, bring the head parallel to the base (4 possible positions) and press the locking lever in the direction of the pan rotation axis. Unlatch the mechanism before starting up the device.

13 TILT LOCK

Mechanical locking mechanism to prevent the head from turning in a vertical direction during transport (7 positions). Disconnect the device from the mains power and push the locking lever in the direction of the tilt rotation axis while moving the head of the device on vertical level until one of the 7 locking positions is found and the locking lever engages. Unlatch the mechanism before starting up the device.

OPERATION

NOTE

As soon as the spotlight is connected correctly to the power, "Software Update Please Wait..." and the Cameo logo with information on the device model will display while the device starts up and the motor resets. The spotlight is ready after this process, and the operating mode that was selected will activate.

The spotlight can be operated using the touch-sensitive control fields next to the display, or the pressure-sensitive display (can be used with gloves) itself can be used to access all menu options and intuitively modify settings as desired. Information on which control element on the display and which control field next to the display have the same functionality can be found in the adjacent table.

The following describes how to operate the device using the control fields next to the display.

Display		Control field
	=	MODE
	=	UP
	=	ENTER
	=	DOWN
	=	LEFT
	=	RIGHT

MAIN DISPLAY

The upper line of the display shows whether and which control signal is present on the device, the line below shows the currently active control mode (DMX Standard / Extended, Static, Auto, Slave), and well visible in the middle is the DMX start address or the corresponding operating mode (e.g. DMX start address 001). As soon as the control signal is interrupted, the characters on the display will begin to flash and "None" will display behind "Signal" on the upper line (no signal). When the control signal is again present, the screen will switch back to the main display. The display can be rotated by 180° by pressing the touch-sensitive DOWN control key. If the display is already rotated 180°, press the UP control key to return the display to its standard position. The display can also be rotated 180° by pressing the "roof" symbol on the pressure-sensitive display.

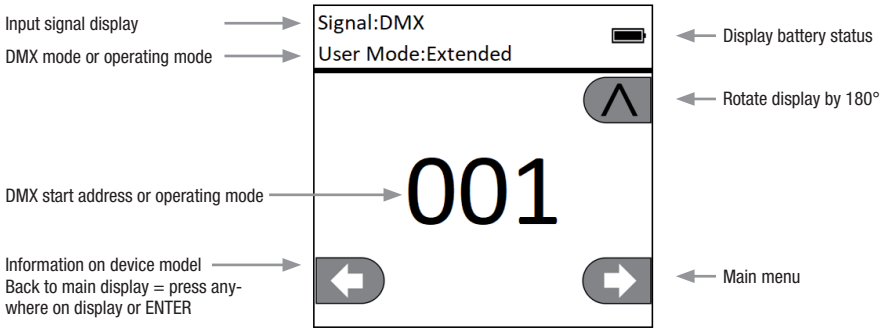

CONTROL MENU (Control)

SETTING THE DMX START ADDRESS (DMX Address)

Starting from the main display, press ENTER to go to the main menu. Use the UP and DOWN control keys to select the Control menu and press ENTER. Using the UP and DOWN buttons, now select the "DMX Address" menu option and confirm via ENTER. Set the desired DMX start address using the LEFT and RIGHT buttons, and confirm via ENTER (highest value depends on active DMX mode). Press MODE 2x to return to the main display, the selected DMX start address will now be displayed enlarged when the DMX mode is active.

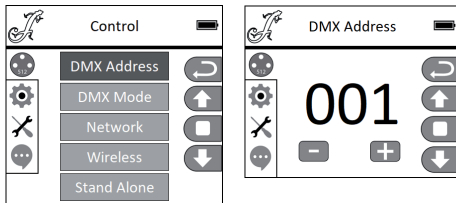

SETTING THE DMX MODE (DMX Mode)

Starting from the main display, press ENTER to go to the main menu. Use the UP and DOWN control keys to select the Control menu and press ENTER. Using the UP and DOWN buttons, now select the "DMX Mode" menu option and confirm via ENTER. Select the desired DMX mode via UP and DOWN and confirm by selecting ENTER. Press MODE 2x to return to the main display, the selected DMX mode is now active. You can find tables on channel assignment in the different DMX modes in these instructions under DMX CONTROL.

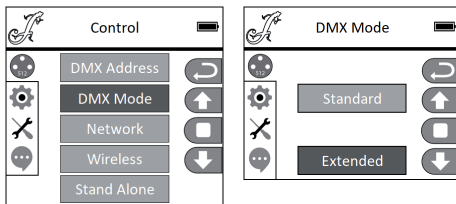

NETWORK SETTINGS (Network)

Starting from the main display, press ENTER to go to the main menu. Use the UP and DOWN control keys to select the Control menu and press ENTER. Using the UP and DOWN buttons, now select the "Network" menu option and confirm via ENTER. Network settings information can be found in the following table. Confirm all network settings changes via ENTER.

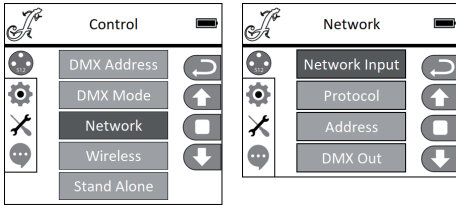

Network			
Network Input	Activate / deactivate network input	OFF	Network input deactivated
		ON	Network input activated
Protocol	Network protocol	ArtNET	ArtNet protocol
		sACN	sACN protocol
Address	Universe 1 - 256, configure IP address and subnet mask	Universe 000 - 255	000 to 255. Change value via LEFT and RIGHT, confirm via ENTER.
		IP address	Select Block via LEFT and RIGHT, change value via UP and DOWN, confirm with ENTER.
		IP Subnet Mask	Select Block via LEFT and RIGHT, change value via UP and DOWN, confirm with ENTER.
DMX OUT	Output network signal via DMX OUT	OFF	Do not output signal
		ON	Output signal

W-DMX SETTINGS (Wireless)

Starting from the main display, press ENTER to go to the main menu. Use the UP and DOWN control keys to select the Control menu and press ENTER. Using the UP and DOWN buttons, now select the "Mode" menu option and confirm via ENTER. W-DMX settings information can be found in the following table. Confirm all settings changes via ENTER.

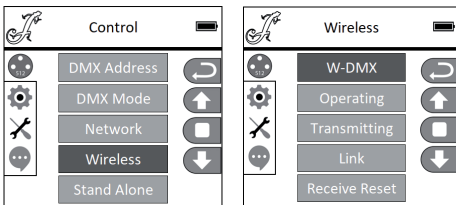

Wireless		
W-DMX	OFF	Deactivate W-DMX
	ON	Activate W-DMX
Operating <i>(currently in beta)</i>	Receiver	W-DMX module configured as receiver
	Transmitter	W-DMX module configured as transmitter
Transmitting <i>(currently in beta)</i>	G3	G3 transmission standard
	G4S	G4S transmission standard
Link	Link	Link with W-DMX devices. W-DMX must be active for all devices and the link with a transmitter must be suspended (Receive Reset)
	UnLink	Unlink all devices
Receive Reset	NO	Do not suspend link with a transmitter
	YES	Suspend link with a transmitter

STAND-ALONE MODES (Stand Alone)

Starting from the main display, press ENTER to go to the main menu. Use the UP and DOWN control keys to select the Control menu and press ENTER. Using the UP and DOWN buttons, now select the "Stand-Along" menu option and confirm via ENTER. Now select one of the three stand-alone modes using the UP and DOWN control keys and confirm via ENTER.

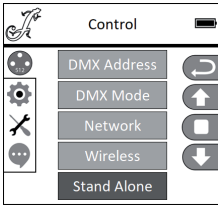

STAND-ALONE STATIC MODE (Static)

The Static mode, similar to a DMX controller, allows PAN, TILT, dimmer, strobe, colour wheel and gobo wheel, etc. to be set directly on the unit with values from 000 to 255. This allows the user to create individual scenes without needing an additional DMX controller. You can configure the settings as desired after you have selected Static mode, as described under "STANDALONE MODES". The submenu options here correspond to channels 1 to 50 in the 50-channel Extended DMX modus (see DMX CONTROL, select submenu options via UP and DOWN, change value via LEFT and RIGHT, confirm via ENTER). Press MODE repeatedly to return to the main screen.

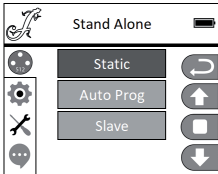

STAND-ALONE AUTO PROGRAM (Auto Prog)

The 4 different Auto programs (Program 1 - 4) consist of pre-programmed head movements, gobo and color changes, etc.; the speed is configured separately. Select Auto mode, as described previously under "STAND-ALONE MODES", confirm via ENTER, select the desired Auto program via UP and DOWN, confirm via ENTER, and now change the value for the speed from 000 to 100 via LEFT and RIGHT as desired. Confirm via ENTER. Press MODE repeatedly to return to the main screen.

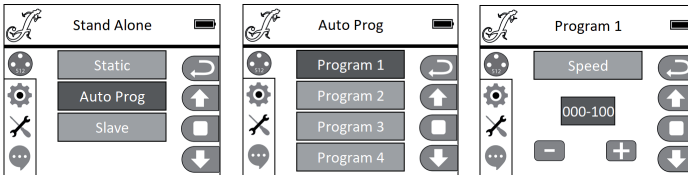

SLAVE MODE (Slave)

Select Slave mode as described previously under "STAND-ALONE MODES". Connect the slave and master unit (same model, same software version) using a DMX cable (Master DMX OUT - Slave DMX IN), and activate one of the stand-alone modes, Auto or Static, on the master unit. The slave unit will now follow the master unit. Press MODE repeatedly to return to the main screen.

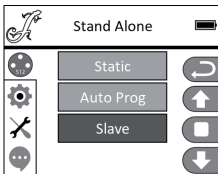

SYSTEM SETTINGS (Settings)

Starting from the main display, press ENTER to go to the main menu. Use the UP and DOWN control keys to select the System Settings menu and press ENTER.

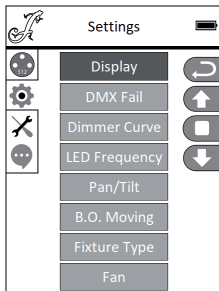

This will take you to the submenu for setting the submenu options, see table (select via UP and DOWN, confirm via ENTER, change status via UP and DOWN, confirm via ENTER):

Settings (bold = factory setting)				
Display	Display settings	Reverse	OFF	Display does not rotate
			ON	Display rotates by 180° (when installed overhead)
		Backlight	OFF	Deactivates display backlight after approx. 30 seconds of inactivity
			ON	Display backlight permanently on
DMX Fail	Operating mode for DMX signal interruption	Black		activates Blackout
		Hold		Last command is held
		Auto		Activates Auto mode
Dimmer Curve	Select the dimmer curve	Linear		The light intensity climbs linearly with the DMX value
		Exponential		The light intensity can be set finely in the lower DMX value range and roughly in the upper DMX value range
		Logarithmic		The light intensity can be set roughly in the lower DMX value range and finely in the upper DMX value range
		S-curve		The light intensity can be set finely in the lower and upper DMX value ranges and roughly in the medium DMX value range
LED Frequency	Sets the LED PWM frequency	650Hz , 1530Hz, 3600Hz, 12KHz, 25KHz		
Pan/Tilt	Configures the device head	Pan Reverse	OFF	Pan movement direction does not reverse
			ON	Pan movement direction reverses
		Tilt Reverse	OFF	Tilt movement direction does not reverse
			ON	Tilt movement direction reverses
		Pan Angle	630	Pan angle 630°
			540	Pan angle 540°
Feedback	OFF	Automatic position correction deactivated		
	ON	Automatic position correction activated		
B.O. Moving	Automatic blackout when head moves	OFF	No blackout when head moves	
		ON	Blackout when head moves	
Fixture Type	Device type	ProfileModule		
		SpotModule		

Fan	Fan control	Head Fan	Auto	The fan speed will adjust automatically to the temperature of the device head
			Low	Consistently low fan speed with reduced brightness, as required
	Base Fan	Auto	The fan speed will adjust automatically to the temperature of the device base	
		Low	Consistently low fan speed with reduced brightness, as required	

DIMMER CURVES

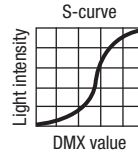
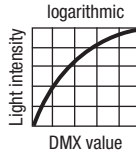
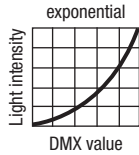
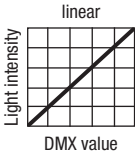

SERVICE MENU

Starting from the main display, press ENTER to go to the main menu. Use the UP and DOWN control keys to select the **Service** menu and press ENTER.

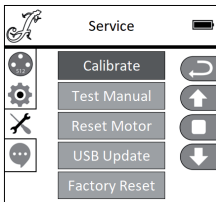

This will take you to the submenu for adjusting the submenu options (select via UP and DOWN, confirm via ENTER, change value via LEFT and RIGHT, confirm via ENTER).

Calibrate - Calibrate the components with values of 000 to 255 (Password 050).

Test Manual - Manually test the components with values of 000 to 255.

Reset Motor - Reset the motors. **All** = All motors, **Pan&Tilt** = pan and tilt motors, **Head Only** = motors in device head.

USB Update - Firmware update via USB interface. **OFF** = Stop firmware update via USB interface. **ON** = Allow firmware update via USB interface.

Factory Reset - Reset to factory settings.

DEVICE INFO (Info)

Starting from the main display, press ENTER to go to the main menu. Use the UP and DOWN control keys to select the **Info** menu and press ENTER.

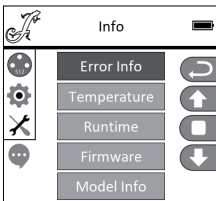

This will take you to the submenu to view the device information (select via UP and DOWN, confirm with ENTER).

System Info			
Error information	Functional error display If it is not possible to eliminate a functional error by resetting or restarting, the faulty unit must be repaired by an authorized service center.		
Temperature	Temperature display	Head	xx°C/F°
		Base	xx°C/F°
		Unit	Displays the temperature in Celsius or Fahrenheit
Runtime	Displays operating hours	Total Time	Displays the total operating time in hours
		Current Time	Displays the current operating time
		Time PW	Inputs the password to reset the current operating time (Time PW = 050)
		Clean Current	Resets the current operating time
Firmware	Displays the firmware of components 1U to 8U	Vx.x.x	
Model Info	Device version information	ProfileModule	Module with framing shutter
		SpotModule	Module with animation wheel

SETUP AND INSTALLATION

Thanks to the integrated rubber feet, the spotlight can be placed in a suitable location on a flat and solid surface. Install on a truss using two omega brackets that are attached to the bottom side of the unit (A). Two omega brackets are included in delivery, suitable truss clamps are optionally available. Make sure that the spotlight is firmly attached and secure it using a suitable safety cable on one of the designated locations (B).



Important info: Overhead installation requires extensive experience, which includes calculating the limit values of the working load of the installation material to be used and regular safety inspections of all installation material and spotlights. If you do not have these qualifications, do not attempt to carry out the installation yourself; contact a professional company.

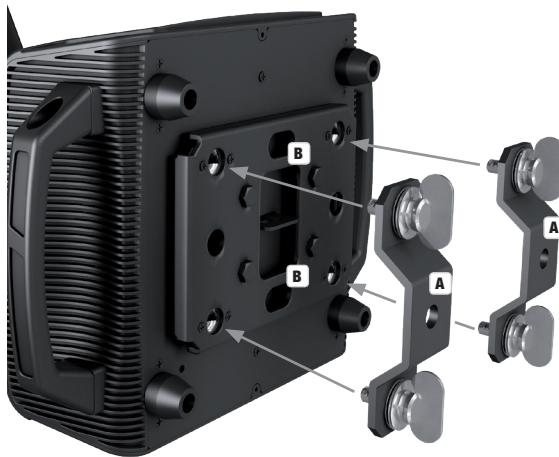

DMX TECHNOLOGY

DMX-512

DMX (Digital Multiplex) is the designation for a universal transmission protocol for communications between corresponding devices and controllers. A DMX controller sends DMX data to the connected DMX device(s). The DMX data is always transmitted as a serial data stream that is forwarded from one connected device to the next via the "DMX IN" and "DMX OUT" connectors (XLR plug-type connectors) that are found on every DMX-capable device, provided the maximum number of devices does not exceed 32 units. The last device in the chain needs to be equipped with a terminator (terminating resistor).



DMX CONNECTION

DMX is the common "language" via which a very wide range of types and models of equipment from various manufacturers can be connected with one another and controlled via a central controller, provided that all of the devices and the controller are DMX compatible. For optimum data transmission, it is necessary to keep the connecting cables between the individual devices as short as possible. The order in which the devices are integrated in the DMX network has no influence on the addresses. Thus the device with the DMX address 1 can be located at any position in the (serial) DMX chain: at the beginning, at the end or somewhere in the middle. If the DMX address 1 is assigned to a device, the controller "knows" that it should send all data allocated to address 1 to this device regardless of its position in the DMX network.

SERIAL CONNECTION OF MULTIPLE LIGHTS

1. Connect the male XLR connector (3-pin or 5-pin) of the DMX cable to the DMX output (female XLR socket) of the first DMX device (e.g. DMX-Controller).
2. Connect the female 3-pin XLR connector of the DMX cable connected to the first projector to the DMX input (male 3-pin socket) of the next DMX device. In the same way, connect the DMX output of this device to the DMX input of the next device and repeat until all devices have been connected. Please note that as a rule, DMX devices are connected in series and connections cannot be shared without active splitters. The maximum number of DMX devices in a DMX chain should not exceed 32 units.

The Adam Hall 3 STAR, 4 STAR, and 5 STAR product ranges include an extensive selection of suitable cables.

DMX CABLES

When fabricating your own cables, always observe the illustrations on this page. Never connect the shielding of the cable to the ground contact of the plug, and always make certain that the shielding does not come into contact with the housing of the XLR plug. If the shielding is connected to the ground, this can lead to short-circuiting and system malfunctions.

Pin Assignment

DMX cable with 3-pin XLR connectors:

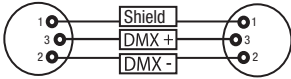

DMX cable with 5-pin XLR connectors (pin 4 and 5 are not used):

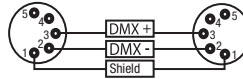

DMX TERMINATORS (TERMINATING RESISTORS)

To prevent system errors, the last device in a DMX chain needs to be equipped with a terminating resistor (120 ohm, 1/4 Watt).

3-pin XLR connector with a terminating resistor: K3DMXT3

5-pin XLR connector with a terminating resistor: K3DMXT5

Pin Assignment

3-pin XLR connector:

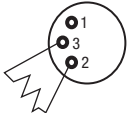

5-pin XLR connector:

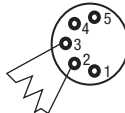

DMX ADAPTER

The combination of DMX devices with 3-pin connectors and DMX devices with 5-pin connectors in a DMX chain is possible with suitable adapters.

Pin Assignment

DMX Adapter 5-pin XLR male to 3-pin XLR female: K3DGF0020

Pins 4 and 5 are not used.

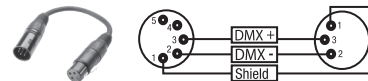

Pin Assignment

DMX Adapter 3-pin XLR male to 5-pin XLR female: K3DHM0020

Pins 4 and 5 are not used.

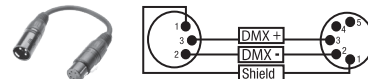

TECHNICAL SPECIFICATIONS

Item number:	CLOSP5P
Product type:	LED moving light
Type:	Moving head
Number of lamps:	1
Type of lamps:	500W LED
Color temperature, lamp:	Cold white 6600K
LED PWM frequency:	650Hz, 1530Hz, 3600Hz, 12kHz, 25kHz (configurable)
Color mix function:	CMY + CTO
Color wheel, number of colors:	7 + open and split colors
Number of gobos:	15 + open (8 fixed + 7 rotating)
Gobo size:	Ø outside 22.9 mm (-0.2 / + 0.1 mm), Ø motif 19 mm, material thickness 1.1 mm (glass)
Beam angle:	6° - 42°
DMX input:	3-pin XLR male 5-pin XLR male
DMX output:	3-pin XLR female 5-pin XLR female
Network connectors:	RJ45 IN and OUT (lockable)
DMX mode:	34-channel, 50-channel
DMX functions:	Pan/Tilt, Pan/Tilt fine, Dimmer, Dimmer fine, multifunctional strobe, Cyan, Cyan fine, Magenta, Magenta fine, Yellow, Yellow fine, CTO, CTO fine, Color Wheel, Color Wheel Rotation, Gobo Wheel 1, Gobo 1 Rotation, Gobo 1 Rotation fine, Gobo Wheel 1 Rotation, Gobo 1 Shake, Gobo Wheel 2, Gobo Wheel 2 Rotation, Gobo 2 Shake, Zoom, Zoom fine, Focus, Focus fine, Iris, Prism, Prism Rotation, Frost, Blade 1 - 4, Blade 1 - 4 fine, Shape Rotation, Shape Rotation fine, Pan/Tilt Macros, Pan/Tilt Speed, Dimmer Curve, System Settings
Standalone functions:	Auto Program 1 - 4, Static Mode, Master/Slave Mode
System settings:	Wireless Setting, Display Reverse, Display Backlight On/Off, DMX Fail, Dimmer Curve, Pan Reverse, Tilt Reverse, Pan Angle, Feedback, Fan Setting, Movement Blackout, Test, Motor Reset, Factory Reset, Network Settings
Controller:	DMX512, RDM enabled, W-DMX™ (receiver), Art-Net, sACN
PAN angle:	540°/630°
TILT angle:	270°
Control elements:	Touch-sensitive MODE, ENTER, UP, DOWN, LEFT, RIGHT control keys, pressure-sensitive graphic color LC display (can be used while wearing gloves)
Display elements:	Backlit graphic color LC display, battery-powered to configure system settings without being connected to power
Operating voltage:	100 - 240V AC / 50 - 60Hz
Power consumption:	800W
Illumination intensity:	> 100000 lx @ 3m
Luminous flux:	> 14500 lm
Power supply connection:	Neutrik TRUE1 in and out (max. output 4A)
Fuse:	T8AL / 250V (5 x 20mm)
Ambient temperature in use:	-15°C - 40°C
Relative humidity:	< 85%, non-condensing
Housing material:	Metal, ABS
Housing color:	Black
Housing cooling:	Heatpipe cooling system plus temperature-controlled fans
Dimensions (B x H x W, with-out mounting bracket):	397 x 741.5 x 285mm
Weight:	27.8kg
Additional features:	1m power cable with TRUE1 plug and 2 omega mounting brackets included in delivery

ENGLISH

DEUTSCH

FRANCAIS

ESPAÑOL

POLSKI

ITALIANO

DMX

MANUFACTURER'S DECLARATIONS

ENGLISH

MANUFACTURER'S WARRANTY & LIMITATIONS OF LIABILITY

You can find our current warranty conditions and limitations of liability at: https://cdn-shop.adamhall.com/media/pdf/MANUFACTURERS-DECLARATIONS_CAMEO.pdf. To request warranty service for a product, please contact Adam Hall GmbH, Adam-Hall-Str. 1, 61267 Neu Anspach / Email: Info@adamhall.com / +49 (0)6081 / 9419-0.



CORRECT DISPOSAL OF THIS PRODUCT

(valid in the European Union and other European countries with a differentiated waste collection system)

■ This symbol on the product, or on its documents indicates that the device may not be treated as household waste. This is to avoid environmental damage or personal injury due to uncontrolled waste disposal. Please dispose of this product separately from other waste and have it recycled to promote sustainable economic activity. Household users should contact either the retailer where they purchased this product, or their local government office, for details on where and how they can recycle this item in an environmentally friendly manner. Business users should contact their supplier and check the terms and conditions of the purchase contract. This product should not be mixed with other commercial waste for disposal.

FCC STATEMENT

This device complies with Part 15 of the FCC Rules. Operation is subject to the following two conditions:

- (1) This device may not cause harmful interference, and
- (2) This device must accept any interference received, including interference that may cause undesired operation

CE Compliance

Adam Hall GmbH states that this product meets the following guidelines (where applicable):

R&TTE (1999/5/EC) or RED (2014/53/EU) from June 2017

Low voltage directive (2014/35/EU)

EMV directive (2014/30/EU)

RoHS (2011/65/EU)

The complete declaration of conformity can be found at www.adamhall.com.

Furthermore, you may also direct your enquiry to info@adamhall.com.

DEUTSCH

FRANCAIS

ESPAÑOL

POLSKI

ITALIANO

DMX

