

USER'S MANUAL
BEDIENUNGSANLEITUNG
MANUEL D'UTILISATION
MANUAL DE USUARIO
INSTRUKCJA OBSŁUGI
MANUALE D'USO



ZENIT[®] W600i

OUTDOOR LED WASH LIGHT FOR FIXED INSTALLATION
CLZW600i

CONTENTS / INHALTSVERZEICHNIS / TABLE DES MATIÈRES / CONTENIDO / SPIS TREŠCI / CONTENUTO

ENGLISH

INFORMATION ON THIS USER MANUAL	6
INTENDED USE	6
DEFINITIONS AND SYMBOL EXPLANATIONS	6
SAFETY INSTRUCTIONS	7
INSTRUCTIONS FOR INSTALLATION EQUIPMENT	10
FEATURES	11
CONNECTIONS, OPERATING AND DISPLAY ELEMENTS	11
SIGNAL AND POWER CABLE	13
OPERATION	15
ADJUSTING LIGHT HEAD TILT	23
INSTALLATION AND TRUSS MOUNTNG	24
INSTALLATION OF OPTIONAL ACCESSORIES	25
INSTALL SPOTLIGHT WITH OPTIONAL MOUNTING PLATE	26
CARE, MAINTENANCE AND REPAIR	27
OPTIONAL ACCESSORIES	29
TECHNICAL DATA	30
EXPLANATION OF IP PROTECTION CLASS	32
EXPLANATORY NOTES ON IK IMPACT RESISTANCE RATING	33
MINIMUM DISTANCE TO ILLUMINATED SURFACE	33
MINIMUM DISTANCE TO NORMALLY FLAMMABLE MATERIALS	33
DISPOSAL	34
MANUFACTURER'S DECLARATIONS	34

DEUTSCH

INFORMATIONEN ZU DIESER BEDIENUNGSANLEITUNG	36
BESTIMMUNGSGEMÄSSER GEBRAUCH	36
BEGRIFFS- UND SYMBOLERKLÄRUNGEN	36
SICHERHEITSHINWEISE	37
HINWEISE FÜR INSTALLATIONSGERÄTE	41
EIGENSCHAFTEN	41
ANSCHLÜSSE, BEDIEN- UND ANZEIGEELEMENTE	42
SIGNAL- UND NETZKABEL	43
BEDIENUNG	45
EINSTELLEN DER LEUCHTKÖRPERNEIGUNG	54
AUFSTELLUNG UND TRAVERSENMONTAGE	55
OPTIONALES ZUBEHÖR MONTIEREN	56
SCHNITTWERFER MITTELN OPTIONALER MONTAGEPLATTE INSTALLIEREN	58
PFLGE, WARTUNG UND REPARATUR	59
OPTIONALES ZUBEHÖR	61
TECHNISCHE DATEN	62
ERLÄUTERUNGEN ZUR IP SCHUTZART	64
ERLÄUTERUNGEN ZUM IK STOSSFESTIGKEITSGRAD	65
MINDESTABSTAND ZUR BELEUCHTETEN FLÄCHE	65
MINDESTABSTAND ZU NORMAL ENTFLAMMBAREN MATERIALIEN	65
ENTSORGUNG	66
HERSTELLERERKLÄRUNGEN	66

CONTENTS / INHALTSVERZEICHNIS / TABLE DES MATIÈRES / CONTENIDO / SPIS TREŠCI / CONTENUTO

FRANÇAIS

INFORMATIONS CONCERNANT CE MANUEL D'UTILISATION	67
UTILISATION CONFORME	67
EXPLICATIONS DES TERMES ET DES SYMBOLES	67
CONSIGNES DE SÉCURITÉ	68
CONSIGNES POUR LES APPAREILS D'INSTALLATION	72
CARACTÉRISTIQUES	72
RACCORDEMENTS, ÉLÉMENTS DE COMMANDE ET D'AFFICHAGE	73
CÂBLES DE SIGNAL ET RÉSEAU	74
UTILISATION	76
RÉGLAGE DE L'INCLINAISON DU CORPS LUMINEUX	85
INSTALLATION ET MONTAGE SUR TRAVERSE	86
MONTAGE DES ACCESSOIRES EN OPTION	87
INSTALLATION DU PROJECTEUR À L'AIDE DE LA PLAQUE DE MONTAGE EN OPTION	89
ENTRETIEN, MAINTENANCE ET RÉPARATION	90
ACCESSOIRES EN OPTION	92
CARACTÉRISTIQUES TECHNIQUES	93
EXPLICATIONS RELATIVES À L'INDICE DE PROTECTION IP	95
EXPLICATIONS RELATIVES À L'INDICE DE RÉSISTANCE AUX CHOCs IK	96
DISTANCE MINIMALE PAR RAPPORT À LA SURFACE ÉCLAIRÉE	96
DISTANCE MINIMALE PAR RAPPORT AUX MATÉRIAUX NORMALEMENT INFLAMMABLES	96
ÉLIMINATION	97
DÉCLARATIONS DU FABRICANT	97

ESPAÑOL

INFORMACIÓN SOBRE ESTE MANUAL DE INSTRUCCIONES	98
USO PREVISTO	98
TÉRMINOS Y SÍMBOLOS	98
INSTRUCCIONES DE SEGURIDAD	99
INSTRUCCIONES PARA LOS EQUIPOS DE INSTALACIÓN	103
CARACTERÍSTICAS	103
CONEXIONES, ELEMENTOS DE MANEJO Y ELEMENTOS DE VISUALIZACIÓN	104
CABLE DE SEÑAL Y DE ALIMENTACIÓN	105
FUNCIONAMIENTO	107
AJUSTE DE LA INCLINACIÓN DE LA LÁMPARA	116
INSTALACIÓN Y MONTAJE EN TRAVESAÑO	117
MONTAJE DE LOS ACCESORIOS OPCIONALES	118
INSTALACIÓN DEL FOCO CON PLACA DE MONTAJE OPCIONAL	120
CUIDADO, MANTENIMIENTO Y REPARACIÓN	121
ACCESORIOS OPCIONALES	123
DATOS TÉCNICOS	124
EXPLICACIÓN SOBRE LA CLASE DE PROTECCIÓN IP	126
EXPLICACIÓN SOBRE EL GRADO DE RESISTENCIA A LOS IMPACTOS IK	127
DISTANCIA MÍNIMA CON RESPECTO A LA SUPERFICIE ILUMINADA	127
DISTANCIA MÍNIMA CON RESPECTO A MATERIALES NORMALMENTE INFLAMABLES	127
ELIMINACIÓN	128
DECLARACIONES DEL FABRICANTE	128

CONTENTS / INHALTSVERZEICHNIS / TABLE DES MATIÈRES / CONTENIDO / SPIS TREŚCI / CONTENUTO

POLSKI

INFORMACJE DOTYCZĄCE NINIEJSZEJ INSTRUKCJI OBSŁUGI	129
UŻYTKOWANIE ZGODNÉ Z PRZEZNACZENIEM	129
OBJAŚNIENIA TERMINÓW I SYMBOLI	129
ZASADY BEZPIECZEŃSTWA	130
UWAGI DOTYCZĄCE URZĄDZEŃ SŁUŻĄCYCH DO MONTAŻU	134
CHARAKTERYSTYKA	134
PRZYŁĄCZA, ELEMENTY OBSŁUGI I WSKAŹNIKI	135
PRZEWÓD SYGNAŁOWY I SIECIOWY	136
OBSŁUGA	138
REGULACJA ODCHYLENIA ŚWIATŁA	147
USTAWIANIE I MONTAŻ NA KRATOWNICY	148
MONTAŻ OPCJONALNYCH AKCESORIÓW	149
INSTALACJA REFLEKTORA PRZY UŻYCIU OPCJONALNEJ PŁYTY MONTAŻOWEJ	151
CZYSZCZENIE, KONSERWACJA I NAPRAWY	152
AKCESORIA DODATKOWE	154
DANE TECHNICZNE	155
OBJAŚNIENIA DOTYCZĄCE STOPNIA OCHRONY IP	157
UWAGI DOTYCZĄCE POZIOMU ODPORNOŚCI NA WSTRZĄSY IK	158
MINIMALNA ODLEGŁOŚĆ OD POWIERZCHNI OŚWIETLONEJ	158
MINIMALNA ODLEGŁOŚĆ OD NORMALNIE ŁATWOPALNYCH MATERIAŁÓW	158
UTYLIZACJA	159
DEKLARACJE PRODUCENTA	159

ITALIANO

INFORMAZIONI SUL PRESENTE MANUALE D'USO	160
UTILIZZO CONFORME	160
SPIEGAZIONE DI CONCETTI E SIMBOLI	160
INDICAZIONI SULLA SICUREZZA	161
NOTE SUI DISPOSITIVI PER INSTALLAZIONI ELETTRICHE	165
CARATTERISTICHE	165
CONNETTORI, ELEMENTI DI COMANDO E DI VISUALIZZAZIONE	166
CAVI DI SEGNALE E DI ALIMENTAZIONE	167
UTILIZZO	169
REGOLAZIONE DELL'INCLINAZIONE DELLA LAMPADA	178
INSTALLAZIONE E MONTAGGIO SU TRAVERSA	179
MONTAGGIO DEGLI ACCESSORI OPZIONALI	180
INSTALLAZIONE DEL PROIETTORE CON LA PIASTRA DI MONTAGGIO OPZIONALE	182
PULIZIA, MANUTENZIONE E RIPARAZIONE	183
ACCESSORI OPZIONALI	185
DATI TECNICI	186
SPIEGAZIONI SUL GRADO DI PROTEZIONE IP	188
SPIEGAZIONI SUL LIVELLO DI RESISTENZA AGLI URTI IK	189
DISTANZA MINIMA DALLA SUPERFICIE ILLUMINATA	189
DISTANZA MINIMA DAI MATERIALI NORMALMENTE INFIAMMABILI	189
SMALTIMENTO	190
DICHIARAZIONI DEL PRODUTTORE	190

**CONTENTS / INHALTSVERZEICHNIS / TABLE DES MATIÈRES / CONTENIDO /
SPIS TREŚCI / CONTENUTO**

DMX

DMX CONTROL / DMX STEUERUNG / PILOTAGE DMX / CONTROL DMX /
STEROWANIE DMX / CONTROLLO DMX

191

YOU HAVE MADE THE RIGHT CHOICE!

This device has been developed and manufactured to the highest quality standards to ensure many years of problem-free operation. Please read this manual carefully to be able to use your new Cameo product quickly and optimally. Further information about Cameo Light is available on our website **CAMEOLIGHT.com**.

INFORMATION ON THIS USER MANUAL

- Carefully read the safety instructions and the entire manual before operating the device.
- Observe the warnings on the device and in the user manual.
- Always keep the user manual within reach.
- If you sell or pass on the device, it is important that you also include this user manual, as it is an integral part of the product.

INTENDED USE

This product is an outdoor spotlight for permanent installation! This spotlight is intended exclusively for professional users and is not suitable for private households or third parties! Use of the product outside the specified technical data and operating conditions, as well as incorrect installation, is considered inappropriate! Liability for damage and third-party damage to persons and property due to inappropriate use is excluded!

The product is not suitable for:

- Use by persons (including children) with limited physical, sensory or mental abilities or lack of experience and knowledge.
- Children (children must be instructed not to play with the device).

DEFINITIONS AND SYMBOL EXPLANATIONS

1. **HAZARD:** The word **HAZARD**, possibly in combination with a symbol, indicates situations in which there is an immediate danger or risk of potentially fatal injury.
2. **WARNING:** The word **WARNING**, possibly in combination with a symbol, indicates situations in which there is an immediate danger or risk of potentially fatal injury.
3. **CAUTION:** The word **CAUTION**, possibly in combination with a symbol, indicates situations or conditions that could result in injury.
4. **ATTENTION:** The word **ATTENTION**, possibly in combination with a symbol, indicates situations or states that may lead to property damage and/or environmental damage



This symbol identifies hazards that can cause electric shock.



This symbol identifies hazardous areas or hazardous situations.



This symbol indicates hazards caused by hot surfaces.



This symbol indicates hazards caused by intense light sources.



This symbol indicates a device in which there are no user-replaceable parts.



This symbol indicates additional information on the operation of the product.

SAFETY INSTRUCTIONS



HAZARD:

1. Do not open the device and do not perform any modifications.
2. If your device no longer functions properly, if liquids or objects get inside it or if it has been damaged in any other way, switch it off immediately and unplug it from the power source. The device may be repaired only by authorised repair technicians.
3. For devices of protection class 1, the protective conductor must be connected correctly. Never disconnect the protective conductor. Devices of protection class 2 do not have a protective conductor.
4. Ensure that live cables are not kinked or otherwise mechanically damaged.
5. Never bypass the device fuse.



WARNING:

1. The device may not be operated if it shows obvious signs of damage.
2. The device may only be installed in a voltage-free state.
3. If the device's power cable is damaged, the device may not be used.
4. Permanently connected power cables may only be replaced by a qualified person.

**CAUTION:**

1. Do not switch on the device if it has been exposed to extreme temperature fluctuations (for example, following transport). Moisture and condensation can damage the device. Switch on the device only when it has reached room temperature.
2. Ensure that the voltage and frequency of the mains supply match the values specified on the device. If the device has a voltage selector switch, do not connect the device until it has been set correctly. Use only suitable power cables.
3. To disconnect the device from the mains on all poles, it is not sufficient to press the on/off switch on the device.
4. Make sure that the fuse used corresponds to the type printed on the device.
5. Ensure that suitable measures have been taken against overvoltage (e.g. lightning strikes).
6. Observe the specified maximum output current on devices with a Power Out connection. Ensure that the total current consumption of all connected devices does not exceed the specified value.
7. Replace pluggable power cables with original cables only.

**HAZARD:**

1. Choking hazard! Plastic bags and small parts must be kept out of reach of persons (including children) with reduced physical, sensory or mental capabilities.
2. Risk of falling! Make sure that the device is securely installed and will not fall down. Only use suitable stands or mountings (particularly for fixed installations). Ensure that accessories are properly installed and secured. Ensure that applicable safety regulations are observed.

**WARNING:**

1. Use the device in the prescribed manner only.
2. Operate the device using only accessories of the type recommended and supplied by the manufacturer.
3. Observe safety regulations applicable in your country during installation.
4. After connecting the device, ensure that all cables are routed so as to avoid damage or accidents, such as from tripping.
5. Always observe the specified minimum distance to normally flammable materials! Unless explicitly stated, the minimum distance is 0.3 m.
6. Always observe the minimum distance to the illuminated surface that can be read on the device!

**CAUTION:**

1. Moving components such as mounting brackets may become jammed.
2. In the case of devices with motor-driven components, there is a risk of injury due to the movement of the device. Sudden movement of the device can cause shock reactions.
3. The housing surface of the device can become very hot during regular operation. Ensure that accidental touching of the housing is not possible. Always allow the lamp to cool sufficiently before removal, maintenance work and charging etc.

**CAUTION:**

1. Do not install or use the device in the vicinity of radiators, accumulators, stoves, or other heat sources. Ensure that the device is always installed in such a way that it is sufficiently cooled and cannot overheat.
2. Do not place any ignition sources, such as burning candles, near the device.
3. Ventilation openings may not be covered and fans may not be blocked.
4. For transport, use the original packaging or packaging provided by the manufacturer.
5. Avoid any impacts to or shaking of the device.
6. Observe the IP rating and the ambient conditions such as temperature and humidity according to the specification.
7. Devices can be continuously further developed. In the event of deviating information on operating conditions, performance or other device properties between the user manual and the device labelling, the information on the device always has priority.
8. The device is not suitable for tropical climate zones or for operation over 2,000 m above sea level.
9. Unless explicitly stated, the device is not suitable for operation under marine conditions.

CAUTION! IMPORTANT INFORMATION REGARDING LIGHTING PRODUCTS!

1. Never look directly into the beam of light, not even for a short period of time.
2. Never look into the beam of light using optical devices such as a magnifying glass.



3. Stroboscopic effects may cause epileptic seizures in those susceptible!



4. A permanently installed lamp is installed in this lighting unit which must not be replaced by the user. In the event of a fault, please contact your sales partner.

INSTRUCTIONS FOR INSTALLATION EQUIPMENT

1. Equipment for installation applications is designed for continuous operation.
2. Equipment for outdoor installation is largely weather-resistant. Depending on the design, however, installed seals may be made of materials that deteriorate over time. These must be checked regularly and replaced if necessary.
3. The correct condition of the housing parts and connections must be checked regularly.
4. Surfaces and plastic parts can also weather in installation equipment, e.g. due to UV irradiation. This generally does not impair functionality.
5. Damage to the surface coating can impair the device's corrosion protection. Damaged surface coating (e.g. scratches) must be promptly repaired by suitable measures.
6. Screw connections can be impaired in their freedom of movement (e.g. due to oxidation or impurities). Here, appropriate measures for loosening are to be implemented.
7. Unless explicitly stated otherwise on the device or in the technical data, the devices are intended for installation heights of less than 5 m.

NOTES FOR INSTALLATION DEVICES

1. units for installation applications are designed for continuous operation.
2. units for outdoor installation are largely weatherproof. However, depending on the design, seals made of ageing materials are installed. These must be checked regularly and replaced if necessary.
3. The correct condition of the housing parts and connections must be checked regularly.
4. Surfaces and plastic parts of installation units can also weather, e.g. due to UV radiation. This does not usually lead to functional restrictions.
5. Damage to the surface coating can impair the corrosion protection of the unit. A damaged surface coating (e.g. scratches) must be restored promptly by suitable measures.
6. The freedom of movement of screw connections can be impaired (e.g. by oxidation or contamination). If necessary, appropriate measures must be taken to loosen them.
7. Unless explicitly stated otherwise on the unit or in the technical data, the units are intended for installation heights of less than 5 m.

FEATURES

IP67 protection rating. Impact resistance rating IK08. 40 x 15 W high-power RGBW LEDs. DMX-512. Strobe. 16-bit dimmer. 4 dimmer curves. Colour temperature correction. Adjustable LED PWM frequency. Fast Access Feature. Plastic feet. 2 x Omega mounting brackets included. Operating voltage 100–240 V AC. Power consumption 565 W. Diffusers, glare shield and mounting plate optionally available.

The spotlight features the RDM standard (Remote Device Management). Remote device management allows the user to view the status and configuration of RDM terminals via an RDM-capable controller.

CONTROL FUNCTIONS

2-channel CCT, 3-channel colour macros, 3-channel RGB 8-bit, 4-channel RGBW 8-bit, 6-channel RGB 16-bit, 8-channel RGBW 8-bit, 8-channel RGBW 16-bit, 10-channel full access 8-bit and 15-channel full access 16-bit DMX control

Master/slave operation

Standalone functions

DELIVERY CONDITION

15-channel full access DMX mode, DMX start address 001

CONNECTIONS, OPERATING AND DISPLAY ELEMENTS

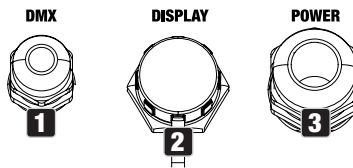

1 DMX

Cable gland with a fixed 5-pin signal cable for DMX input and output.

2 CONNECTION FOR DISPLAY MODULE

Connection socket for an external module with display and touch-sensitive controls (optional). The socket has a cover cap with seal. Ensure that the socket is securely closed with the cover cap when the module is not connected.

3 POWER

Cable gland with a fixed power cable for power supply.

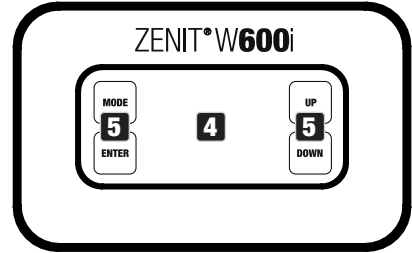
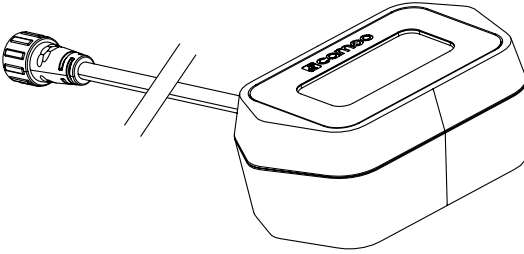
**DISPLAY MODULE**

A special external module with display and touch-sensitive controls is optionally available for configuring the spotlight (product number CLZIEXDISP). The module is connected to the spotlight using a special connecting cable. Ensure that the connections are tightly sealed and that moisture cannot penetrate into the spotlight housing and the housing of the display module. Once the spotlight configuration is complete, the module must be disconnected from the spotlight again and the connection on the spotlight must be securely sealed using the cover cap. The module can now be used to configure additional spotlights.

4 OLED DISPLAY

The OLED display shows the currently activated mode (main display), the menu items in the selection menu and the numerical value or operational status in certain menu items.

5 TOUCH-SENSITIVE CONTROLS**MODE**

Press MODE to access the main menu. Press repeatedly to return to the main display.

ENTER

Press ENTER to access the menu levels to make value changes, and to access the sub-menus. Confirm value changes by pressing ENTER.

UP and DOWN

Select individual menu items in the selection menu (DMX address, operating mode etc.) and in the sub-menus. Allow changes to be made to a menu item setting such as the DMX address as required.

PRESSURE EQUALISATION ELEMENT

The pressure equalisation element to prevent condensation forming inside the housing is located in the base of the device. In order to ensure its proper function, the element must be protected from contamination by regular cleaning.

HOUSING FAN

The three IP67-rated housing fans and heat sink are located on the rear of the LED unit. To ensure air circulation, do not cover the device and clean it regularly.

SIGNAL AND POWER CABLE



There are no plugs or sockets at the cable ends of the DMX signal cable and the cable for the spotlight's power supply. Therefore, the spotlight may only be wired by trained specialist personnel. Extensive knowledge of handling data and power cables, as well as the creation of waterproof connections and junctions according to protection class IP67, is required.

If you do not have these qualifications, do not attempt to install cables yourself. Refer instead to a qualified professional. Liability is excluded for damage resulting from improper handling in all work steps necessary for safe operation. Ensure that no mains voltage is present in cables and spotlights during all work steps that are necessary for cabling.

DMX SIGNAL CABLE

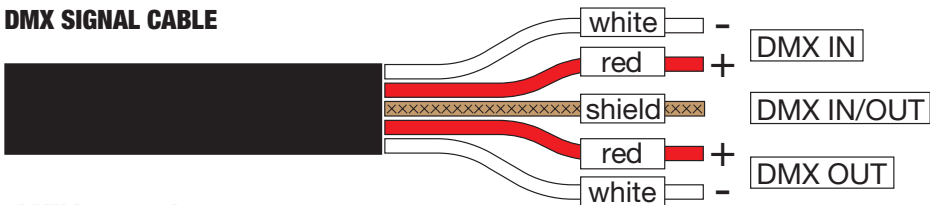

DMX input and output

white	DMX IN	minus (-)
red	DMX IN	plus (+)
shield	DMX IN/OUT	
red	DMX OUT	plus (+)
white	DMX OUT	minus (-)

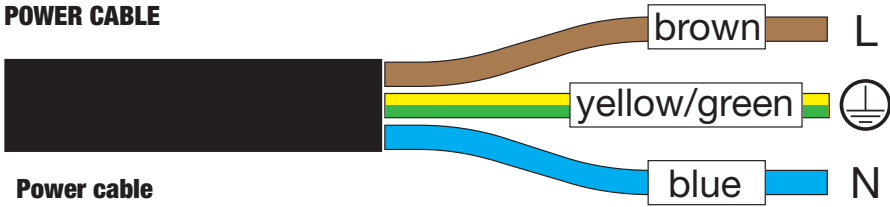
POWER CABLE**Power cable**

brown	Phase (L)
yellow/green	Grounding conductor
blue	Neutral (N)

PLEASE NOTE

No display module connected to the spotlight:

- When the spotlight is supplied with mains voltage, the start-up process begins. During the start-up process, the previously selected operating mode is activated and the spotlight is operational after a short time.

Display module connected to the spotlight:

- When the spotlight is supplied with mains voltage, the start-up process begins and the following are displayed in succession: "Welcome to Cameo", the model name and the software version. During the start-up process, the previously selected operating mode is activated and the spotlight is operational after a short time.
- Before changing device settings, ensure that the control panel is dry and free of dust in order not to impair its functionality.
- If one of the DMX operating modes is activated and there is no DMX signal to the DMX input, the currently programmed DMX address is displayed and the characters on the display will begin to flash.
- The main display is activated automatically if there is no input for a period of approximately one minute.

Fast Access Feature: In order to simplify the menu guide, the device has an intelligent menu structure that allows direct access to previously selected menu items and submenu items.

1. Press MODE and ENTER simultaneously for direct access to the last-edited submenu item, where you can make changes instantly as required (DMX starting address and all modes).
 2. Press MODE to go directly to the last selected and edited menu item. If you now repeatedly press ENTER, you can access the submenu items to make individual settings (DMX start address and all operating modes).
- The display can be rotated through 180° by pressing UP when the main display is visible.
 - To quickly change a value (e.g. DMX start address), press and hold the UP or DOWN controls.

OPERATION

MAIN DISPLAY

The main display shows the currently activated operating mode (in the example: DMX operating mode with start address 001).

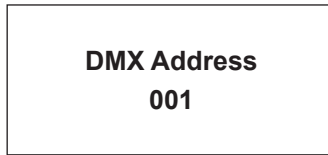

CONFIGURING DMX START ADDRESS (DMX Address)

Press MODE to access the main menu (--- Menu ---). Using the UP and DOWN controls, select the menu item **DMX address** (observe arrow) and confirm with ENTER. The display will show a three-digit number field and you can use the UP and DOWN controls to configure the desired DMX start address. Confirm the entry with ENTER and press MODE to return to the main display (in the example, "DMX address 001").

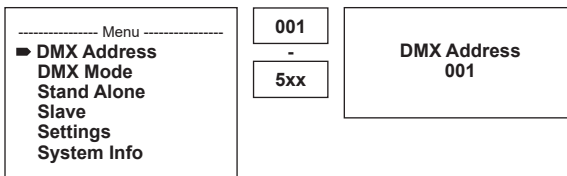

CONFIGURING DMX MODE (DMX Mode)

Press MODE to access the main menu (--- Menu ---). Using the UP and DOWN controls, select the menu item **DMX Mode** (observe arrow) and confirm with ENTER. In the submenu, you can now select from the different DMX modes with UP and DOWN. Confirm your selection with ENTER. Tables with the channel assignments can be found in these instructions under DMX CONTROL.

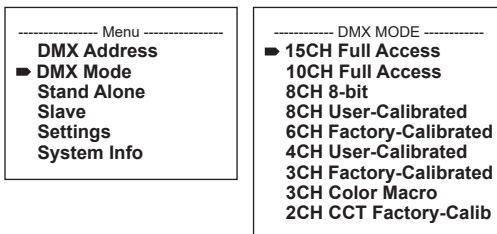

CONFIGURE STANDALONE MODE

Press MODE to access the main menu (--- Menu ---). Use UP and DOWN to select the menu item **Stand Alone** (observe arrow) and confirm with ENTER. In the sub-menu you can now select from the standalone modes **Auto**, **Color Macro**, **Static**, **Tunable White**, und **User Color** and the timer feature **Timer** with the UP and DOWN controls. Confirm your selection with ENTER.

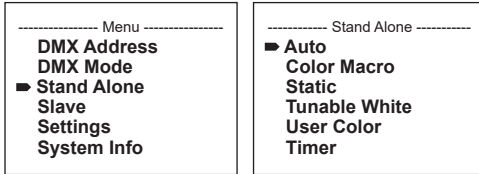

AUTO MODE (Program 1 to Program 6)

The 6 different auto-programs each comprise non-editable colour-change sequences. Brightness and speed are independently adjustable. Select auto mode as described above under "CONFIGURE STANDALONE MODE" and confirm with ENTER. Now use UP and DOWN to select one of the 6 auto programs (observe arrow) and confirm with ENTER. To adjust brightness, use UP and DOWN to select the menu item **Dim** and confirm with ENTER, then use UP and DOWN to select the desired value between 000 and 255. Confirm with ENTER. Set the run speed by selecting the menu item **Speed**, confirm with ENTER, and then select the desired value between 001 and 100. Confirm with ENTER. Press MODE four times to return to the main display (Mode Auto).

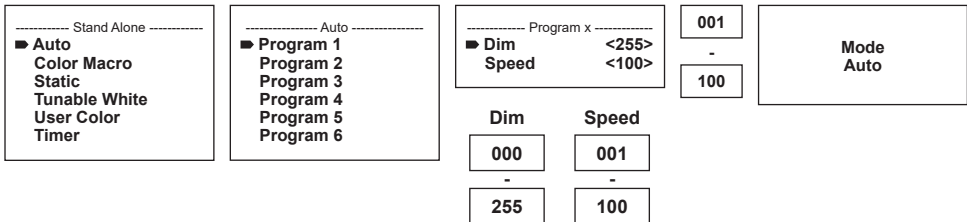

COLOUR MACROS (Color Macro)

15 different preset colour macros are available. Select **Color Macro** as described above under CONFIGURE STANDALONE MODE and confirm with ENTER. Using the UP and DOWN controls, now select the desired colour preset (observe arrow) and confirm with ENTER (Colour Off = blackout). A three-digit figure is shown on the display, and you can set the desired brightness on a scale from 000 to 100 using UP and DOWN. Confirm with ENTER. Press MODE three times to return to the main display (Color Macro Mode).

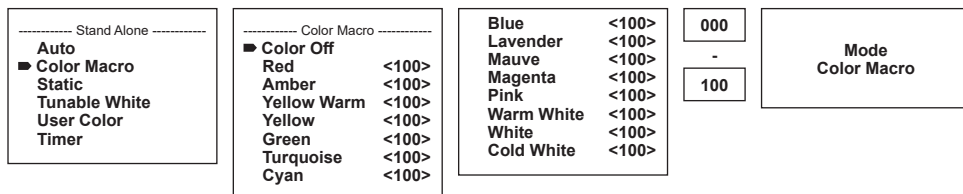

STATIC MODE (Static)

Static mode allows the functions Dimmer, Strobe and R, G, B, W to be adjusted directly on the device with values between 000 and 255, in a similar way to with a DMX controller. In this way, an individual scene can be created without an additional DMX controller. Select the static mode as per the procedure previously described in SETTING STAND ALONE MODE and confirm with ENTER. Now use UP and DOWN to select the menu item you wish to edit (observe arrow) and confirm with ENTER. The display will now show a three-digit number field, and you can use UP and DOWN to configure the desired value between 000 and 255. Confirm with ENTER. Press MODE three times to return to the main display (Static Mode).

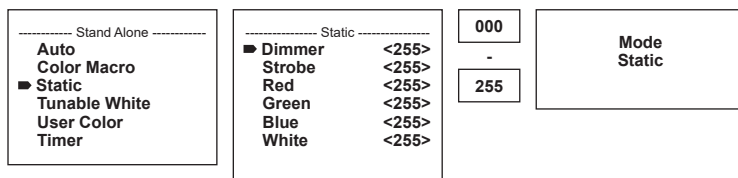

COLOUR TEMPERATURE (Tunable White)

The colour temperature mode enables you to configure the colour temperature from cold white to warm white (CCT) and the brightness (Dim) of the light directly on the device. Select the colour temperature mode as per the procedure previously described in SETTING STAND ALONE MODE and confirm with ENTER. Now use UP and DOWN to select the menu item you wish to edit (observe arrow) and confirm with ENTER. The display will now show a three-digit number field and you can use UP and DOWN to configure the desired value. Confirm with ENTER. Press MODE three times to return to the main display (Mode Tunable White).

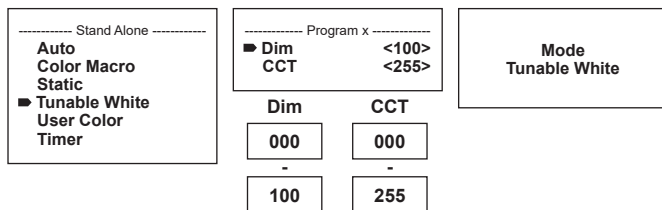

USER PRESETS (User Color)

The operating mode "User Presets" allows the overall brightness and a colour mixture of R, G, B and W to be saved directly in the device in five individual colour presets. Select the **User Color** mode as per the procedure previously described in SETTING STAND ALONE MODE and confirm with ENTER. Use UP AND DOWN to select one of the stored presets Color1 to Color5 and confirm with ENTER and select the submenu item you want to edit (see arrows). Confirm with ENTER. The display will show a three-digit number field and you can use the UP and DOWN controls to set the value as required between 000 and 255. Confirm by pressing ENTER again. When all settings are configured as required, press MODE four times to return to the main display (Mode User Colour).

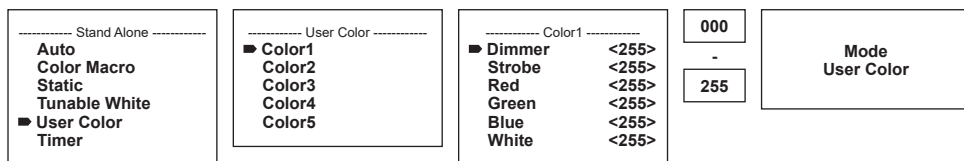

TIMER FUNCTION (Timer)

The timer function allows the standalone modes “Colour Macro”, “Static”, “Tunable White” and “User Colour” to be timer controlled in such a way that the fade-in time can be set from 0 to 60 minutes, the dwell time from 1 to 24 hours and the fade-out time from 0 to 60 minutes. Time control starts immediately after activating the timer function in the previously activated standalone mode and remains active even if the spotlight is switched off and restarted. Select **Timer** as per the procedure described above under CONFIGURE STANDALONE MODE and confirm with ENTER. Now select “Fade In”, “Dwell Time” or “Fade Out” for the individual settings (observe arrow) and confirm with ENTER. The display will show a three-digit number field in each case. Use UP and DOWN to set the value as required from 000 to 060 or 001 to 024. Confirm by pressing ENTER again. Once all settings have been configured as required, activate the timer function by selecting the submenu item “Timer On/Off” using UP and DOWN, confirm with ENTER, select “On” and confirm again with ENTER (to deactivate the timer function, please select “Off” and confirm). Press MODE three times to return to the main display .

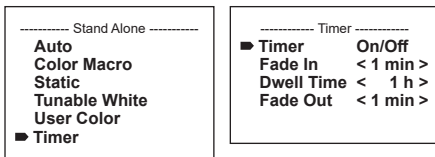

Please note: The timer function is suitable for use in master/slave mode via cable.

SLAVE MODE CONFIGURATION

Press MODE to access the main menu (--- Menu ---). Using UP and DOWN, select the menu item **Slave** (observe arrow) and confirm with ENTER. Connect the slave and the master units (same model, same software version) with a DMX cable and enable one of the standalone modes on the master unit (Auto, Color Macro, Static, Tunable White, User Color). The slave unit will now follow the master unit. If there is no control signal, the display characters will flash. Flashing stops as soon as a control signal is present.

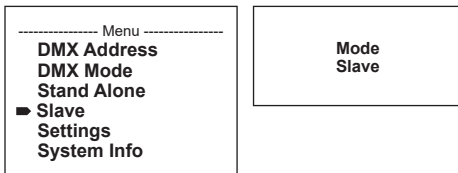

DEVICE SETTINGS (Settings)

Press MODE to access the main menu (--- Menu ---). Using the UP and DOWN controls, select the menu item **Settings** (observe arrow) and confirm with ENTER.

----- Menu -----
DMX Address
DMX Mode
Stand Alone
Slave
▀ Settings
System Info

This will take you to the submenu for setting the following submenu items (see table, select with UP and DOWN, confirm with ENTER, change value or status with UP and DOWN, confirm with ENTER):

Settings (device settings)				
Display Backlight	=	Display lighting	On	Permanently on
			Off	Deactivation after approximately 1 minute of inactivity
DMX Fail	=	Operating status with DMX signal fault	Hold	Last command is retained
			Blackout	Activates blackout
			Emergency Light	Spotlight changes to colour macro "Cold White"
Dimmer Curve	=	Dimmer curve	Linear	Light intensity increases linearly with DMX value
			Exponential	Light intensity can be finely adjusted at lower DMX values and broadly adjusted at higher DMX values
			Logarithmic	Light intensity can be broadly adjusted at lower DMX values and finely adjusted at higher DMX values
			S-curve	Light intensity can be finely adjusted at lower and higher DMX values and broadly adjusted at medium DMX values.
Dimmer Response	=	Dimmer response	LED	Lamp responds abruptly to changes in DMX value
			Halogen	Spotlight behaves like a halogen spotlight with soft brightness changes

Color Calibration	=	Colour calibration (If one of the factory-calibrated DMX modes is activated, no other calibration can be selected and “no possible change in this DMX Mode” is shown on the display. If one of the DMX modes with user calibration is activated, RAW can be selected as an alternative calibration)	RAW	R, G, B and W with maximum value 255
			User Calibration	Individual adaptation of R, G, B, and W with values of 000 to 255 each (across all modes)
			Factory Calibration	Factory calibration of R, G, B and W (across all modes). Select this setting for uniform display of the colour macros in standalone mode, as well as for control of the colour macros via DMX.
Autolock	=	Automatic locking of the controls	On	Automatic locking of the controls after approximately 1 minute of inactivity. Display shown upon attempted use: “Locked!” Unlock: Press and hold UP and DOWN simultaneously for approx. 5 seconds
			Off	Automatic locking of the controls is disabled
LED Frequency	=	LED PWM frequency	800 Hz / 1200 Hz / 2000 Hz / 3600 Hz / 12 kHz / 25 kHz	Configuration of LED PWM frequency
Fan	=	Adjust fan control	Auto	Automatic adjustment of the fan performance
			Max. Intensity	Maximum fan capacity for maximum brightness
			Low Noise	Extra-quiet fan with reduced brightness
Factory Reset	=	Reset to factory settings		Reset to factory settings: ENTER -> “Reset Now!” -> ENTER

Dimmer curves

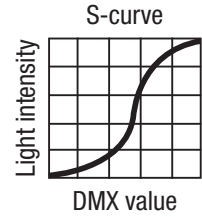
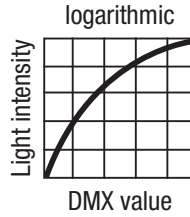
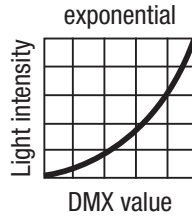
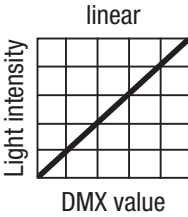

SYSTEM INFORMATION (System Info)

Press MODE to access the main menu (--- Menu ---). Using the UP and DOWN controls, select **System Info** (observe arrow) and confirm with ENTER.

----- Menu -----	
DMX Address	
DMX Mode	
Stand Alone	
Slave	
Settings	
▀ System Info	

Use the UP and DOWN controls to select the desired submenu item, and press ENTER to display the corresponding information.

System Info				
Firmware	=	Displays device firmware	Main CPU	Vx.xx
			LED Driver	Vx.xx
Temperature	=	Displays temperature of LED unit	LED	xx °C / xx °F
			Unit	°C (= display in degrees Celsius) °F (= display in degrees Fahrenheit)
Operation Hours	=	Displays operating time	xx:xx h	Displays total operating time in hours and minutes

MANUAL LOCKING FUNCTION

In addition to the ability to automatically protect the lamp from accidental and unauthorised operation (see "Settings" - "Auto-lock"), the controls can also be locked manually. Press and hold the UP and DOWN controls simultaneously for approximately 5 seconds. If an attempt is made to change settings, "Locked!" will appear in the display, and changing the spotlight's settings via the controls is no longer possible. After approx. 1 minute, the current operating mode is displayed again. To unlock, press and hold the UP and DOWN controls simultaneously for approximately 5 seconds. The display will show the previously displayed information.

ADJUSTING LIGHT HEAD TILT

The light head tilt is adjusted using the supplied face spanner (A). Loosen the two-hole screws on both sides of the retaining bracket (B) only so far that the light head moves freely, adjust to the desired light head tilt and re-tighten the two-hole screws. Be careful not to over-tighten the two-hole screws.

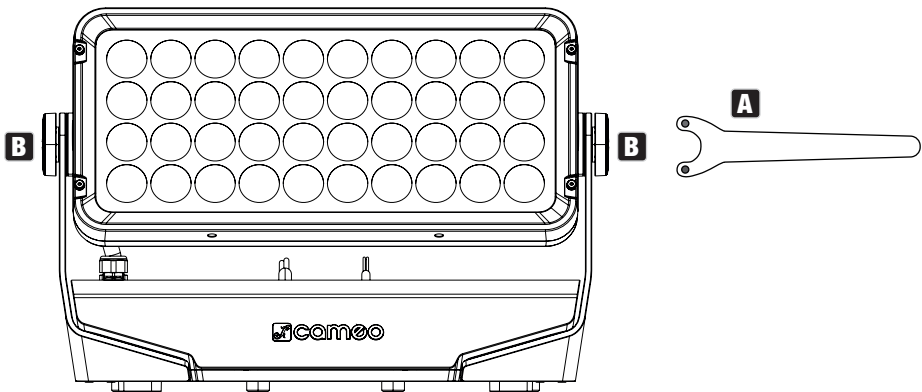

INSTALLATION AND TRUSS MOUNTING

Thanks to its integrated plastic feet, the lamp can be positioned in a suitable location on a level surface. Installation on a truss is carried out with the help of two Omega brackets, which are mounted on the underside of the device base with a suitable tool (A). 2 x Omega brackets, 4 x M8 socket screws and washers are included. Suitable truss clamps are optionally available. Ensure firm connections and secure the spotlight to the intended position (B) with a suitable safety cable if required.



HAZARD: Overhead mounting requires extensive experience, including the calculation of the load limit values of the installation material and regular safety inspection of all installation materials and spotlights. If you do not have these qualifications, do not attempt to perform an installation yourself. Refer instead to a qualified professional. There is a risk that devices that are incorrectly mounted and secured may come loose and fall down. This can cause serious injury or death.

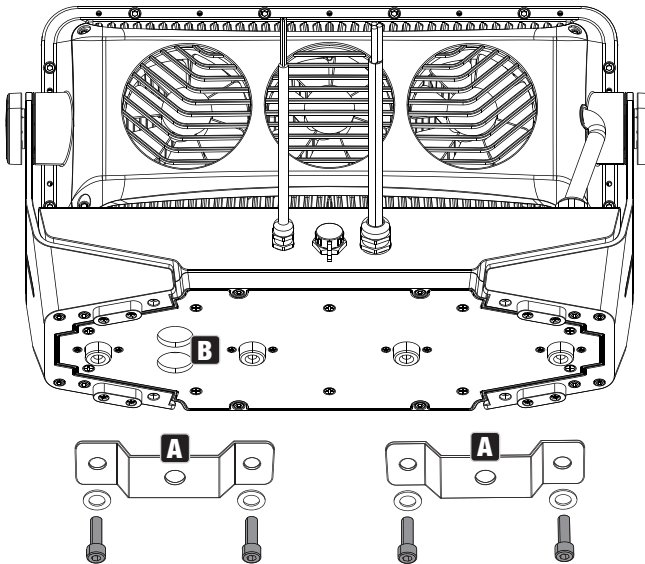

INSTALLATION OF OPTIONAL ACCESSORIES

DIFFUSER AND GLARE SHIELD

To mount accessories such as the diffuser and glare shield, loosen the 4 socket screws (see markings) using a suitable tool. Install the desired glare shield and, if required, a diffuser in the frame of the glare shield, then screw both to the spotlight using the previously loosened screws. The protection against foreign bodies and water, in accordance with protection class IP67, remains unchanged. Diffusers and glare shields in a range of designs are optionally available (see OPTIONAL ACCESSORIES).

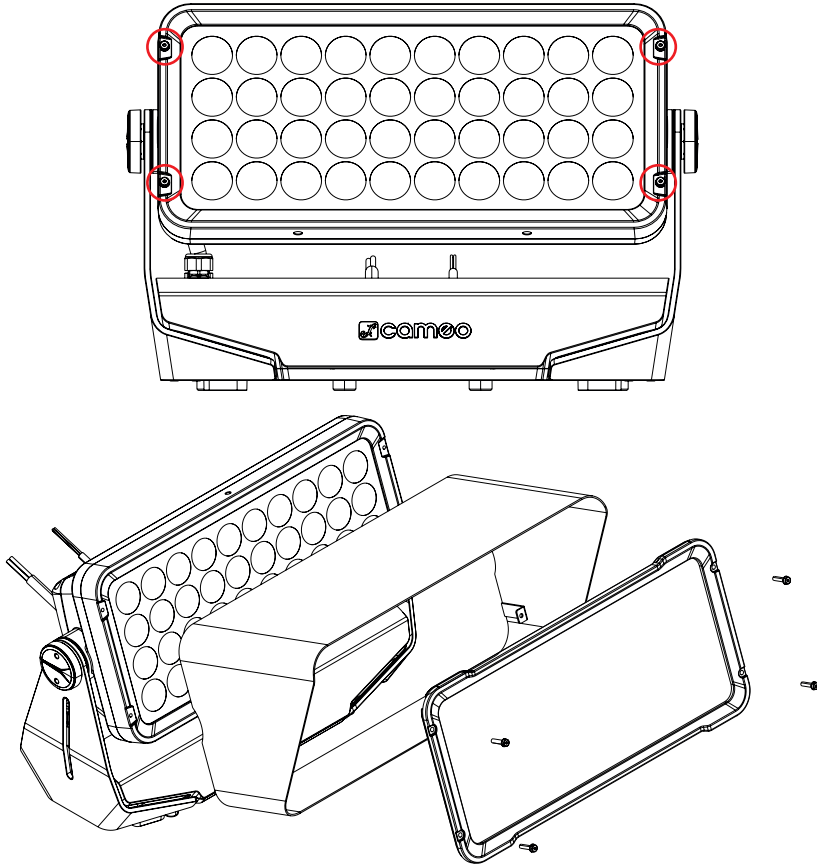

MOUNTING PLATE

Position the mounting plate on the underside of the spotlight base so that the holes in the base plate and the corresponding screw threads in the base are precisely aligned. Now fix the mounting plate to the base using the 4 supplied M4 screws and then secure the mounting plate to the spotlight base using the 4 M8 socket screws supplied with the spotlight.

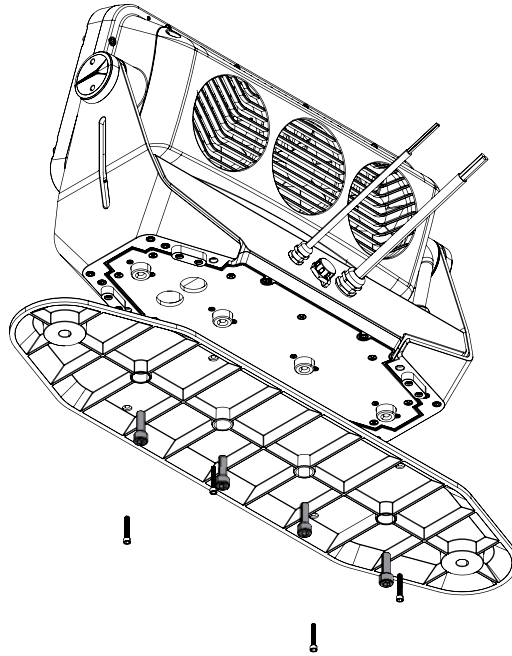

INSTALL SPOTLIGHT WITH OPTIONAL MOUNTING PLATE

When attaching the spotlight to a surface, make sure that the surface is suitable for this purpose and provides sufficient support. Ensure that the installation materials, such as screws and plugs, etc., are suitable for mounting the spotlight and the surface material. Ensure that all screw connections are firmly secured.



HAZARD: Overhead mounting requires extensive experience, including the calculation of the load limit values of the installation material and regular safety inspection of all installation materials and spotlights. If you do not have these qualifications, do not attempt to perform an installation yourself. Refer instead to a qualified professional. There is a risk that devices that are incorrectly mounted and secured may come loose and fall down. This can cause serious injury or death.

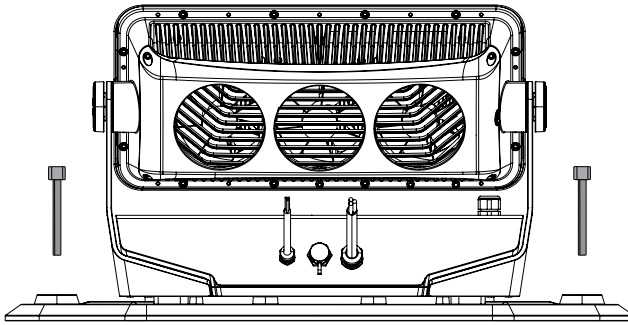

CARE, MAINTENANCE AND REPAIR

In order to ensure the long-term, proper functioning of the device, it must be regularly cleaned and, if necessary, maintained. The maintenance requirement depends on the intensity of use and the environment in which it is used. We generally recommend a visual inspection before each operation. Furthermore, we recommend carrying out all the applicable maintenance measures specified below once every 500 operating hours or, in the case of a lower intensity of use, at the latest after one year. Warranty claims may be limited in the event of defects resulting from inadequate maintenance.

CARE (carried out by user)



WARNING! Before carrying out any care or maintenance, the power supply – and, if possible, all device connections – must be disconnected.



PLEASE NOTE! Improper care can lead to impairment of the device or even its destruction.

1. Housing surfaces must be cleaned with a clean, damp cloth. Make sure that no moisture can penetrate the device.
2. Air inlets and outlets must be regularly cleaned of dust and dirt. If compressed air is used, make sure that damage to the device is prevented (e.g. fans must be blocked in this case, as they could otherwise over-rev.).
3. Lines and plug contacts must be cleaned regularly and dust and dirt must be removed.
4. In general, no cleaning agents or abrasive agents may be used, otherwise the surface finish may be damaged.
5. Devices must generally be stored dry and protected from dust and dirt.
6. To ensure correct and safe operation, all accessible or removable lenses and light-emitting apertures must be cleaned regularly.

MAINTENANCE AND REPAIR (by qualified personnel only)



HAZARD! There are live components in the device. Even after disconnecting the mains connection, there may still be residual voltage in the device, for example, due to charged capacitors.



PLEASE NOTE! There are no user-serviceable assemblies in the device.

PLEASE NOTE! Maintenance and repair work may only be carried out by sufficiently qualified specialist personnel. If in doubt, consult a specialist workshop.

PLEASE NOTE! Improperly performed maintenance work may affect the warranty claim.

PLEASE NOTE! For conversion or retrofit sets provided by the manufacturer, it is essential to observe the enclosed installation instructions.

Clean fan

The three IP67-rated fans on the back of the LED unit of the spotlight must be regularly checked for functionality and, if necessary, cleaned. Disconnect the spotlight from the power supply (if necessary, switch off the whole installation). Loosen the 4 socket screws holding the fan cover to the LED unit using a suitable tool. Remove the fan cover from the LED unit, clean the fans and check that the fans can rotate freely. If compressed air is used, make sure that damage to the device is prevented (e.g. fans must be blocked in this case, as they could otherwise over-rev.). Clean the ventilation openings of the fan cover and fasten the cover again with the previously loosened screws.

If a fan should become blocked despite cleaning, take the spotlight out of operation and contact an authorised service centre.

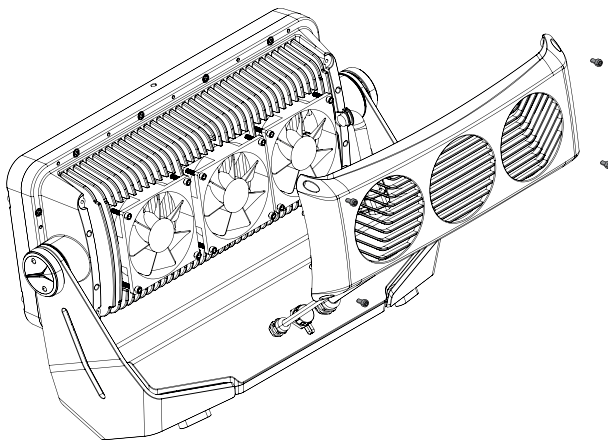

OPTIONAL ACCESSORIES

Diffusers



Product number	Diffusion angle
CLZW600ISMLD20	25°
CLZW600ISMLD40	45°
CLZW600ISMLD100	100°
CLZW600ISMLD6010	60° x 10°

Mounting plate

Product number CLZW600IMP



Glare shield (half top hat)

Product number CLZW600IHALFGS



Glare shield (full top hat)

Product number CLZW600IFULLGS



Display module with controls including 2 m connecting cable

Product number CLZIEXDISP



TECHNICAL DATA

PRODUCT NUMBER:	CLZW600i
Product type:	LED wash light
Type:	Outdoor spotlight
Colour spectrum LED:	RGBW
No. of LEDs:	40
LED type:	15 W 4-in-1 SMD
LED PWM frequency:	800 Hz, 1200 Hz, 2000 Hz, 3600 Hz, 12 kHz, 25 kHz (adjustable)
Beam angle:	18° (35° field)
Interfaces:	Fixed 5-pin signal line (DMX In and Out), 2 m, with open ends for connection to an external module with OLED display and controls
DMX mode:	2-channel CCT, 3-channel colour macro, 3-channel factory-calibrated, 4-channel user-calibrated, 6-channel factory-calibrated, 8-channel user-calibrated, 8-channel 8-bit, 10-channel, 15-channel
DMX functions:	Dimmer, dimmer fine, RGBW, RGBW fine, strobe, dimmer curves, colour temperature correction, dimmer response, colour macros, colour change, colour blending, system settings
Standalone functions:	Colour mixing, colour macros, master/slave operation, auto programs, static (RGBW), tunable white, user colour, timer, strobe
System settings:	Rotate display by 180°, display lighting, DMX fail, dimmer curves, dimmer response, colour calibration, LED PWM frequency, fan control, factory reset
Control:	DMX512, RDM-enabled
Operating elements:	External module with OLED display and mode, enter, up, down (optionally available)
Display elements:	External module with OLED display and mode, enter, up, down (optionally available)
Operating voltage:	100–240 V AC / 50–60 Hz
Power supply connection:	Fixed power cable H07RN-F, 3 x 1.5 mm ² , 2 m, open ends
Electrical protection class:	1
Maximum power consumption:	565 W
Inrush current:	2.5 A @ 230 V / 5.6 A @ 100 V
Light intensity (@ 1 m, without diffuser):	120,000 lx
Luminous flux (RGBW):	21,000 lm
Efficiency:	37.2 lm/W
Power factor:	0.99 PF (120 V) / 0.96 PF (230 V)
Ambient temperature (in operation):	-15°C to +45°C

Housing material:	die-cast aluminium
Housing colour:	Black
Corrosion resistance:	C5-M powder coating
Housing cooling:	3 x IP67 fans
Protection class:	IP67
Cable glands:	Protection class IP68
Impact resistance rating:	IK08
Maximum installation height:	Unlimited
Projected area (EPA):	0.12 m ² (0.15 m ² with half top hat glare shield and mounting plate)
Operating situation:	As required
Minimum distance to normal flammable materials:	0.5 m
Minimum distance to illuminated surface:	0.5 m
Dimensions (W x H x D, without bracket):	449 x 291 x 161 mm
Weight (not including accessories):	13 kg
Accessories supplied:	Face spanner. 2 x Omega brackets and 4 x M8 x 25 mounting bolts plus U-washers. 4 x M4 x 18 socket screws for attaching the diffuser and glare shield
Optional accessories:	<ul style="list-style-type: none"> • External module with OLED display and controls incl. 2 m connection cable • Mounting plate with 4 x M4 x 25 socket screws • Diffusers (25°, 45°, 100°, 60° x 10°) • Glare shield half top hat • Glare shield full top hat

EXPLANATION OF IP PROTECTION CLASS

1. An IP rating only reflects protection from solid objects and water.

It does not describe general weather resistance, such as protection from UV radiation and temperature, etc.

2. The first identification digit indicates protection from dust, solid objects and contact:

IP2X	Protected against solid foreign bodies \geq 12.5 mm in diameter
IP3X	Protected against solid foreign bodies \geq 2.5 mm in diameter
IP4X	Protected against solid foreign bodies \geq 1.0 mm in diameter
IP5X	Protected against dust in harmful quantities and completely protected against contact
IP6X	Are dust-tight and completely protected against contact

3. The second identification digit indicates protection from water:

IPX0	no protection
IPX1	Protection against dripping water
IPX2	Protection against dripping water when the device is tilted up to 15°
IPX3	Protection against falling spray water up to 60° from the vertical
IPX4	Protection against splashing water on all sides
IPX5	Protection against water jets (nozzle) from any angle
IPX6	Protection against strong water jets
IPX7	Protection against temporary immersion

4. In addition, some device-specific measures such as covers and sealing caps are necessary in order to achieve the specified protection class (e.g. protective caps on unused connections).



The IP rating of the product can be found in the technical data and is printed on the device.

EXPLANATORY NOTES ON IK IMPACT RESISTANCE RATING

The IK impact resistance rating is a measure of the resistance of a housing (in the case of electrical equipment) to impact stress. It is standardised according to CEI EN 50102 and describes how much impact energy (in Joules) the housing can withstand without breaking.

IK00	No impact resistance
IK01	Impact resistance up to impact energy of 0.14 J
IK02	Impact resistance up to impact energy of 0.2 J
IK03	Impact resistance up to impact energy of 0.35 J
IK04	Impact resistance up to impact energy of 0.5 J
IK05	Impact resistance up to impact energy of 0.7 J
IK06	Impact resistance up to impact energy of 1.0 J
IK07	Impact resistance up to impact energy of 2.0 J
IK08	Impact resistance up to impact energy of 5.0 J
IK09	Impact resistance up to impact energy of 10.0 J
IK10	Impact resistance up to impact energy of 20.0 J
IK10+	Impact resistance up to impact energy of 50.0 J



The impact resistance rating of the product can be found in the technical data and is printed on the device.

MINIMUM DISTANCE TO ILLUMINATED SURFACE

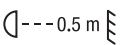
 This symbol with distance specification in metres (m) indicates the minimum distance between the light head and the illuminated surface. In this example the distance is 0.5 m.

MINIMUM DISTANCE TO NORMALLY FLAMMABLE MATERIALS

 This symbol with distance specification in metres (m) indicates the minimum distance between the light head and normally flammable materials. In this example the distance is 0.5 m.

DISPOSAL



Packaging:

1. Packaging can be fed into the reusable material cycle using the usual disposal methods.
2. Please separate the packaging in accordance with the disposal laws and recycling regulations in your country.



Device:

1. This device is subject to the European Directive on Waste Electrical and Electronic Equipment, as amended. WEEE Directive Waste Electrical and Electronic Equipment. Old appliances do not belong in household waste. The old device must be disposed of via an approved disposal company or a municipal disposal facility. Please observe the applicable regulations in your country!
2. Observe all disposal laws applicable in your country.
3. As a private customer, you can obtain information on environmentally-friendly disposal options from the seller of the product or the appropriate regional authorities.

MANUFACTURER'S DECLARATIONS

MANUFACTURER'S WARRANTY & LIMITATION OF LIABILITY

Adam Hall GmbH, Adam-Hall-Str. 1, D-61267 Neu Anspach / E-mail Info@adamhall.com / +49 (0)6081 / 9419-0.

Our current warranty conditions and limitation of liability can be found at:

https://cdn-shop.adamhall.com/media/pdf/Manufacturers-Declarations-CAMEO_DE_EN_ES_FR.pdf.

Contact your sales partner for service.

CE CONFORMITY

Adam Hall GmbH hereby confirm that this product meets the following guidelines (where applicable):

Low-Voltage Directive (2014/35/EU)

EMC Directive (2014/30/EU)

RoHS (2011/65/EU)

RED (2014/53/EU)

CE CONFORMITY DECLARATION

Declarations of conformity for products subject to the LVD, EMC, RoHS Directive can be requested from info@adamhall.com. Declarations of conformity for products subject to RED can be downloaded from www.adamhall.com/compliance/.

UKCA- CONFORMITY

Hereby, Adam Hall Ltd. declares that this product meets the following guidelines (where applicable)

Electrical Equipment (Safety) Regulations 2016

Electromagnetic Compatibility Regulations 2016 (SI 2016/1091)

The Restriction of the Use of Certain Hazardous Substances in Electrical and Electronic Equipment Regulation 2012 (SI 2012/3032)

Radio Equipment Regulations 2017 (SI 2016/2015)

UKCA- DECLARATION OF CONFORMITY

Products that are subject to Electrical Equipment(Safety)Regulation 2016, EMC Regulation 2016 or RoHS Regulation can be requested at info@adamhall.com.

Products that are subject to the Radio Equipments Regulations 2017 (SI2017/1206) can be downloaded from www.adamhall.com/compliance/

-

DMX CONTROL / DMX STEUERUNG / PILOTAGE DMX / CONTROL DMX / STEROWANIE DMX / CONTROLLO DMX

15 CH Full Access 16 Bit						
Ch.	Function	Values			Sub-Group	
1	Dimmer	000	-	255	0% to 100%	Dimmer
2	Dimmer fine	000	-	255	0% to 100%	
3	Strobe functions	000	-	005	Strobe open	Multifunctional strobe
		006	-	010	Strobe closed	
		011	-	033	Pulse random slow -> fast	
		034	-	056	Ramp up random slow -> fast	
		057	-	079	Ramp down random slow -> fast	
		080	-	102	Random strobe effect slow -> fast	
		103	-	127	Strobe break effect, 5s.....1s (short burst with break)	
		128	-	250	Strobe slow -> fast <1Hz - 20Hz	
		251	-	255	Strobe open	
4	Red	000	-	255	0% to 100%	Red
5	Red fine	000	-	255	0% to 100%	
6	Green	000	-	255	0% to 100%	
7	Green fine	000	-	255	0% to 100%	Green
8	Blue	000	-	255	0% to 100%	
9	Blue fine	000	-	255	0% to 100%	Blue
10	White	000	-	255	0% to 100%	
11	White fine	000	-	255	0% to 100%	White
12	Color Macros (override RGBW)	000	-	005	Color off	
		006	-	013	Red	
		014	-	021	Amber	
		022	-	029	Yellow warm	
		030	-	037	Yellow	
		038	-	045	Green	
		046	-	053	Turquoise	
		054	-	061	Cyan	
		062	-	069	Blue	
		070	-	077	Lavender	
		078	-	085	Mauve	
		086	-	093	Magenta	
		094	-	101	Pink	
		102	-	109	Warm White	
		110	-	117	White	
		118	-	125	Cold White	
		126	-	127	Color Jumping stop	
128	-	191	Color Jumping speed slow -> fast / color 1 -> 12			
192	-	255	Color Fading speed slow -> fast / color 1 -> 12			

13	ColorTemperature Correction (affects RGBW & Color Macros)	000	-	005	off	Color Temperature Correction
		006	-	006	Warm White	
		007	-	046	Warm White - 2700 k	
		047	-	047	Bulb White (2700 k)	
		048	-	087	2700 k - 3200 k	
		088	-	088	Halogen White (3200 k)	
		089	-	128	3200 k - 4000 k	
		129	-	129	Neutral White (4000 k)	
		130	-	169	4000 k - 5600 k	
		170	-	170	Studio White (5600 k)	
		171	-	210	5600 k - 6500 k	
		211	-	211	Daylight White (6500 k)	
		212	-	251	6500 k - Cold Daylight	
		252	-	255	Cold Daylight	
14	Set dimmer curve	000	-	005	No function	Set dimmer curve
		006	-	063	Linear dimmer curve	
		064	-	127	Exponential dimmer curve	
		128	-	191	Logarithmic dimmer curve	
		192	-	255	S-Curve dimmer curve	
15	Device settings (please read remark 1*)	000	-	077	No function	Control
		078	-	079	Dimmer response LED (hold 1,5 s)	
		080	-	081	Dimmer response halogen (hold 1,5s)	
		082	-	101	No function	
		102	-	103	Silent fan (hold 3s)	
		104	-	105	Auto fan (hold 3s)	
		106	-	123	No function	
		124	-	125	PWM 1 (800 Hz) (hold 3s)	
		126	-	127	PWM 2 (1200 Hz) (hold 3s)	
		128	-	129	PWM 3 (2000 Hz) (hold 3s)	
		130	-	131	PWM 4 (3600 Hz) (hold 3s)	
		132	-	133	PWM 5 (12 kHz) (hold 3s)	
		134	-	135	PWM 6 (25 kHz) (hold 3s)	
		136	-	143	No function	
		144	-	145	Display on (hold 3s)	
		146	-	147	Display off (hold 3s)	
		148	-	205	No function	
		206	-	207	Raw mode (hold 3s)	
208	-	209	Factory calibrated mode (hold 3s)			
210	-	211	User calibrated mode (hold 3s)			
212	-	255	No function			

10 CH Full Access 8 Bit

Ch.	Function	Values				Sub-Group
1	Dimmer	000	-	255	0% to 100%	Dimmer

2	Strobe functions	000	-	005	Strobe open	Multifunctional strobe
		006	-	010	Strobe closed	
		011	-	033	Pulse random slow -> fast	
		034	-	056	Ramp up random slow -> fast	
		057	-	079	Ramp down random slow -> fast	
		080	-	102	Random strobe effect slow -> fast	
		103	-	127	Strobe break effect, 5s.....1s (short burst with break)	
		128	-	250	Strobe slow -> fast <1Hz - 20Hz	
251	-	255	Strobe open			
3	Red	000	-	255	0% to 100%	Red
4	Green	000	-	255	0% to 100%	Green
5	Blue	000	-	255	0% to 100%	Blue
6	White	000	-	255	0% to 100%	White
7	Color Macros (override RGBW)	000	-	005	Color off	Color Macros
		006	-	013	Red	
		014	-	021	Amber	
		022	-	029	Yellow warm	
		030	-	037	Yellow	
		038	-	045	Green	
		046	-	053	Turquoise	
		054	-	061	Cyan	
		062	-	069	Blue	
		070	-	077	Lavender	
		078	-	085	Mauve	
		086	-	093	Magenta	
		094	-	101	Pink	
		102	-	109	Warm White	
		110	-	117	White	
		118	-	125	Cold White	
126	-	127	Color Jumping stop			
128	-	191	Color Jumping speed slow -> fast / color 1 -> 12			
192	-	255	Color Fading speed slow -> fast / color 1 -> 12			
8	Color Temperature Correction (affects RGBW & Color Macros)	000	-	005	off	Color Temperature Correction
		006	-	006	Warm White	
		007	-	046	Warm White - 2700 k	
		047	-	047	Bulb White (2700 k)	
		048	-	087	2700 k - 3200 k	
		088	-	088	Halogen White (3200 k)	
		089	-	128	3200 k - 4000 k	
		129	-	129	Neutral White (4000 k)	
		130	-	169	4000 k - 5600 k	
		170	-	170	Studio White (5600 k)	
		171	-	210	5600 k - 6500 k	
		211	-	211	Daylight White (6500 k)	
		212	-	251	6500 k - Cold Daylight	
		252	-	255	Cold Daylight	

9	Set dimmer curve	000		005	No function	Set dimmer curve
		006	-	063	Linear dimmer curve	
		064	-	127	Exponential dimmer curve	
		128	-	191	Logarithmic dimmer curve	
		192	-	255	S-Curve dimmer curve	
10	Device settings (please read remark 1*)	000	-	077	No function	Control
		078	-	079	Dimmer response LED (hold 1,5 s)	
		080	-	081	Dimmer response halogen (hold 1,5s)	
		082	-	101	No function	
		102	-	103	Silent fan (hold 3s)	
		104	-	105	Auto fan (hold 3s)	
		106	-	123	No function	
		124	-	125	PWM 1 (800 Hz) (hold 3s)	
		126	-	127	PWM 2 (1200 Hz) (hold 3s)	
		128	-	129	PWM 3 (2000 Hz) (hold 3s)	
		130	-	131	PWM 4 (3600 Hz) (hold 3s)	
		132	-	133	PWM 5 (12 kHz) (hold 3s)	
		134	-	135	PWM 6 (25 kHz) (hold 3s)	
		136	-	143	No function	
		144	-	145	Display on (hold 3s)	
		146	-	147	Display off (hold 3s)	
		148	-	205	No function	
206	-	207	Raw mode (hold 3s)			
208	-	209	Factory calibrated mode (hold 3s)			
210	-	211	User calibrated mode (hold 3s)			
212	-	255	No function			

8 CH 8 Bit						
Ch.	Function	Values				Sub-Group
1	Dimmer	000	-	255	0% to 100%	Dimmer
2	Strobe functions	000	-	005	Strobe open	Multifunctional Strobe
		006	-	010	Strobe closed	
		011	-	033	Pulse random, slow -> fast	
		034	-	056	Ramp up random, slow -> fast	
		057	-	079	Ramp down random, slow -> fast	
		080	-	102	Random Strobe effect, slow -> fast	
		103	-	127	Strobe Break effect, 5s.....1s (short burst with break)	
128	-	250	Strobe slow -> fast <1Hz - 20Hz			
		251	-	255	Strobe open	
3	Red	000	-	255	0% to 100%	Red
4	Green	000	-	255	0% to 100%	Green
5	Blue	000	-	255	0% to 100%	Blue
6	White	000	-	255	0% to 100%	White

7	Color Macros (override RGBW)	000	-	005	Color off	Color Macro
		006	-	013	Red	
		014	-	021	Amber	
		022	-	029	Yellow warm	
		030	-	037	Yellow	
		038	-	045	Green	
		046	-	053	Turquoise	
		054	-	061	Cyan	
		062	-	069	Blue	
		070	-	077	Lavender	
		078	-	085	Mauve	
		086	-	093	Magenta	
		094	-	101	Pink	
		102	-	109	Warm White	
		110	-	117	White	
		118	-	125	Cold White	
126	-	127	Color Jumping stop			
128	-	191	Color Jumping speed slow -> fast / Color 1 -> 12			
192	-	255	Color Fading speed slow -> fast / Color 1 -> 12			
8	Device Settings (please read remark 1*)	000	-	077	no function	Control
		078	-	079	Dimmer response LED (hold 1,5 s)	
		080	-	081	Dimmer response halogen (hold 1,5s)	
		082	-	101	No function	
		102	-	103	Silent fan (hold 3s)	
		104	-	105	Auto fan (hold 3s)	
		106	-	123	No function	
		124	-	125	PWM 1 (800 Hz) (hold 3s)	
		126	-	127	PWM 2 (1200 Hz) (hold 3s)	
		128	-	129	PWM 3 (2000 Hz) (hold 3s)	
		130	-	131	PWM 4 (3600 Hz) (hold 3s)	
		132	-	133	PWM 5 (12 kHz) (hold 3s)	
		134	-	135	PWM 6 (25 kHz) (hold 3s)	
		136	-	143	No function	
		144	-	145	Display on (hold 3s)	
		146	-	147	Display off (hold 3s)	
		148	-	205	No function	
		206	-	207	Raw mode (hold 3s)	
208	-	209	Factory calibrated mode (hold 3s)			
210	-	211	User calibrated mode (hold 3s)			
212	-	255	No function			

8 CH User-Calibrated 16 Bit						
Ch.	Function	Values				Sub-Group
1	Red	000	-	255	0% to 100%	Red
2	Red fine	000	-	255	0% to 100%	
3	Green	000	-	255	0% to 100%	Green
4	Green fine	000	-	255	0% to 100%	

5	Blue	000	-	255	0% to 100%	Blue
6	Blue fine	000	-	255	0% to 100%	
7	White	000	-	255	0% to 100%	
8	White fine	000	-	255	0% to 100%	White

6 CH Factory-Calibrated 16 Bit						
Ch.	Function	Values				Sub-Group
1	Red	000	-	255	0% to 100%	Red
2	Red fine	000	-	255	0% to 100%	
3	Green	000	-	255	0% to 100%	Green
4	Green fine	000	-	255	0% to 100%	
5	Blue	000	-	255	0% to 100%	Blue
6	Blue fine	000	-	255	0% to 100%	

4 CH User-Calibrated 8 Bit						
Ch.	Function	Values				Sub-Group
1	Red	000	-	255	0% to 100%	Red
2	Green	000	-	255	0% to 100%	Green
3	Blue	000	-	255	0% to 100%	Blue
4	White	000	-	255	0% to 100%	White

3 CH Factory-Calibrated 8 Bit						
Ch.	Function	Values				Sub-Group
1	Red	000	-	255	0% to 100%	Red
2	Green	000	-	255	0% to 100%	Green
3	Blue	000	-	255	0% to 100%	Blue

3 CH Color Macros						
Ch.	Function	Values				Sub-Group
1	Dimmer	000	-	255	0% to 100%	Dimmer
2	Strobe functions	000	-	005	Strobe open	Multifunctional strobe
		006	-	010	Strobe closed	
		011	-	033	Pulse random slow -> fast	
		034	-	056	Ramp up random slow -> fast	
		057	-	079	Ramp down random slow -> fast	
		080	-	102	Random strobe effect slow -> fast	
		103	-	127	Strobe break effect, 5s.....1s (short burst with break)	
		128	-	250	Strobe slow -> fast <1Hz - 20Hz	
251	-	255	Strobe open			

3	Color Macros	000	-	005	Color off	Color Macros
		006	-	013	Red	
		014	-	021	Amber	
		022	-	029	Yellow warm	
		030	-	037	Yellow	
		038	-	045	Green	
		046	-	053	Turquoise	
		054	-	061	Cyan	
		062	-	069	Blue	
		070	-	077	Lavender	
		078	-	085	Mauve	
		086	-	093	Magenta	
		094	-	101	Pink	
		102	-	109	Warm White	
		110	-	117	White	
		118	-	125	Cold White	
126	-	127	Color Jumping stop			
128	-	191	Color Jumping speed slow -> fast / color 1 -> 12			
192	-	255	Color Fading speed slow -> fast / color 1 -> 12			

2 CH CCT Factory-Calibrated						
Ch.	Function	Values				Sub-Group
1	Dimmer	000	-	255	0% to 100%	Dimmer
2	Color Temperature	000	-	005	off	Color Temperature
		006	-	006	Warm White	
		007	-	046	Warm White - 2700 k	
		047	-	047	Bulb White (2700 k)	
		048	-	087	2700 k - 3200 k	
		088	-	088	Halogen White (3200 k)	
		089	-	128	3200 k - 4000 k	
		129	-	129	Neutral White (4000 k)	
		130	-	169	4000 k - 5600 k	
		170	-	170	Studio White (5600 k)	
		171	-	210	5600 k - 6500 k	
		211	-	211	Daylight White (6500 k)	
		212	-	251	6500 k - Cold Daylight	
		252	-	255	Cold Daylight	

EN: (1*) After the adjustments have been made, set the value to 000 to avoid disturbance by endless function call.

DE: (1*) Nachdem die Einstellungen vorgenommen wurden, stellen Sie den Wert auf 000 ein, um Störungen durch endlosen Funktionsaufruf zu vermeiden.

FR: (1*) Une fois les ajustements effectués, réglez la valeur sur 000 pour éviter les perturbations par appel de fonction sans fin.

ES: (1*) Después de realizar los ajustes, establezca el valor en 000 para evitar perturbaciones mediante una llamada de función sin fin.

PL: (1*) Po dokonaniu ustawień ustaw wartość na 000, aby uniknąć zakłóceń przez niekończące się wywołanie funkcji.

IT: (1*) Dopo aver effettuato le regolazioni, impostare il valore su 000 per evitare disturbi causati da una chiamata a funzione infinita.

