

USER'S MANUAL
BEDIENUNGSANLEITUNG
MANUEL D'UTILISATION
MANUAL DE USUARIO
INSTRUKCJA OBSŁUGI
MANUALE D'USO



DROP® B4

BATTERY POWERED OUTDOOR UPLIGHT
CLDROPB4 / CLDROPB4WH

CONTENTS / INHALTSVERZEICHNIS / CONTENU / CONTENIDO / TREŚĆ / CONTENUTO

ENGLISH

SAFETY INFORMATION	3
INTRODUCTION	5
CONNECTIONS, OPERATING AND DISPLAY ELEMENTS OPERATION	6
IR REMOTE CONTROL (OPTIONAL)	7
DIFFUSERS	12
INSTALLATION AND MOUNTING	13
DMX TECHNOLOGY	14
TECHNICAL DATA	15
MANUFACTURER'S DECLARATIONS	16
DMX CONTROL	17

DEUTSCH

SICHERHEITSHINWEISE	18
EINFÜHRUNG	21
ANSCHLÜSSE, BEDIEN- UND ANZEIGEELEMENTE	22
BEDIENUNG	23
IR FERNBEDIENUNG	29
STREUSCHEIBEN	30
AUFSTELLUNG UND MONTAGE	30
DMX TECHNIK	32
TECHNISCHE DATEN	33
HERSTELLERERKLÄRUNGEN	34
DMX STEUERUNG	103

FRANCAIS

CONSIGNES DE SÉCURITÉ	35
INTRODUCTION	38
RACCORDEMENTS, ÉLÉMENTS DE COMMANDE ET D'AFFICHAGE	39
UTILISATION	40
TÉLÉCOMMANDE INFRAROUGE (EN OPTION)	46
DIFFUSEURS	47
INSTALLATION ET MONTAGE	47
TECHNOLOGIE DMX	49
CARACTÉRISTIQUES TECHNIQUES	50
DÉCLARATIONS DU FABRICANT	51
PILOTAGE DMX	103

ESPAÑOL

INSTRUCCIONES DE SEGURIDAD	52
INTRODUCCIÓN	55
CONEXIONES, ELEMENTOS DE MANEJO Y ELEMENTOS DE VISUALIZACIÓN	56
FUNCIONAMIENTO	57
MANDO A DISTANCIA POR INFRARROJOS (OPCIONAL)	63
DIFUSORES	64
INSTALACIÓN Y MONTAJE	64
TECNOLOGÍA DMX	66
DATOS TÉCNICOS	67
DECLARACIONES DEL FABRICANTE	68
CONTROL DMX	103

POLSKI

ZASADY BEZPIECZEŃSTWA	69
WPROWADZENIE	72
PRZYŁĄCZA, ELEMENTY OBSŁUGI I WSKAŹNIKI	73
OBSŁUGA	74
PILOT ZDALNEGO STEROWANIA (OPCJONALNY)	80
DYFUZORY	81
USTAWIANIE I MONTAŻ	81
TECHNIKA DMX	83
DANE TECHNICZNE	84
OŚWIADCZENIA PRODUCENTA	85
STEROWANIE DMX	103

ITALIANO

INDICAZIONI SULLA SICUREZZA	86
INTRODUZIONE	89
CONNESSIONI, ELEMENTI DI COMANDO E DI VISUALIZZAZIONE	90
UTILIZZO	91
TELECOMANDO A INFRAROSSI (OPZIONALE)	97
DIFFUSORI	98
INSTALLAZIONE E MONTAGGIO	98
TECNOLOGIA DMX	100
DATI TECNICI	101
DICHIARAZIONI DEL PRODUTTORE	102
CONTROLLO DMX	103

YOU HAVE MADE THE RIGHT CHOICE!

This device was developed and produced under the highest standards of quality in order to ensure smooth operation for many years. Please read these operating instructions carefully so that you can use your new Cameo Light product quickly and optimally. You can find more information on Cameo Light on our website WWW.CAMEOLIGHT.COM.

SAFETY INFORMATION

1. Please read through these instructions carefully.
2. Store all information and instructions in a secure location.
3. Follow the instructions.
4. Heed all warnings. Do not remove any safety warnings or other information from the device.
5. Use the device only in the intended manner.
6. Use only stable and suitable stands and/or mounts (for fixed installations). Make sure that wall mounts are properly installed and secured. Make sure that the device is securely installed and will not fall.
7. During installation, heed all safety provisions that apply in your country.
8. Do not install and operate the device in the vicinity of heaters, heat reservoirs, ovens, or other heat sources. Make sure that the device is installed in such a way that it is sufficiently cooled and will not overheat.
9. Do not place any ignition sources, e.g. candles, on the device.
10. Do not block the ventilation slits.
11. The device was designed to be used only in interior spaces, do not operate the device in the direct vicinity of water (this does not apply to specialty outdoor devices - in this case, please note the special instructions given in the following). Do not bring the device into contact with combustible materials, fluids, or gases.
12. Make sure that no water can drop or splash into the device. Do not place any containers filled with fluids, such as vases or drinking vessels, onto the device.
13. Ensure that no objects can fall into the device.
14. Operative the device using only those accessories recommended and specified by the manufacturer.
15. Do not open the device, and do not modify it.
16. After connecting the device, inspect all cable paths in order to avoid damage or accidents, such as those caused by tripping over said cables.
17. During transport, ensure that the device will not fall and potentially cause material damage and personal harm.
18. If your device no longer functions properly, fluids or objects have made their way into the device interior, or the device is otherwise damaged, switch it off immediately and remove it from the power outlet (provided the device is active). This device is to be repaired only by authorized specialists.
19. Use a dry towel to clean the device.
20. Follow all laws on disposal applicable in your country. Please separate plastic and paper or cardboard when disposing of the packaging.
21. Plastic bags must be kept out of reach of children.

FOR DEVICES CONNECTED TO A POWER SUPPLY:

22. ATTENTION: If the device power cable is equipped with a ground pin, it must be inserted into an outlet with a grounding conductor. Never disable the grounding conductor of a power cable.
23. Do not immediately switch on the device when it has been exposed to stark temperature deviations (for example after transport). Humidity and condensation could damage the device. Switch on the device only when it has reached room temperature.
24. Before you connect the device to the outlet, first ensure that voltage and frequency of the power supply complies with the values given on the device. If the device has a voltage selector switch, connect the device to the outlet only if the device values comply with the values of the power supply. If the provided power cable or power adapter does not fit your power outlet, contact an electrician.
25. Do not step on the power cable. Make sure that live cables, in particular those at the power socket or at the power adapter and the device socket, are not bent.
26. With regard to the device cables, always make sure that the power cable or power adapter is always freely accessible. Always separate the device from the power supply when the device is not in use or when you would like to clean the device. Always unplug the power cable and power adapter from the power outlet using the plug or adapter, not the cord. Never touch the power cable and power adapter with wet hands.
27. If possible, do not switch the device on and off quickly because this may impair the service life of the device.
28. IMPORTANT INFO: Replace fuses only with fuses of the same type and value. If a fuse trips repeatedly, please contact an authorized service center.
29. In order to completely separate the device from the power supply, remove the power cable or power adapter from the outlet.
30. If your device is equipped with a Volex power cord, release the correct Volex device connector before removing the cord. However, this also means that the device may slide and fall when removing the power cord, which may cause personal harm and/or material damage. Therefore, always lay cables carefully.
31. Remove the power cable and power adapter from the outlet when there is a risk of lighting or when you no longer want to use the device.
32. The device may only be installed when it carries no voltage (separate the power plug from the power supply).
33. Dust and other debris within the device may damage it. The device should be serviced or cleaned regularly by qualified specialists depending on the environmental conditions (dust, nicotine, smoke, etc.) in order to avoid overheating.
34. The distance to combustible materials must be at least 0.5 m.
35. Power cables for powering multiple devices must have a core cross-section of at least 1.5 mm². In the EU, lines must be H05VV-F or similar. Adam Hall provides suitable cables. Using these cables, you can connect multiple devices via the Power Out connection with the Power In connection of another device. Ensure that the total power consumption of all connected devices does not exceed the specified value (printed on the device). Be sure to keep power lines as short as possible.

36. The appliance is not to be used by persons (including children) with reduced physical, sensory or mental capabilities, or lack of experience and knowledge.

37. Children must be instructed not to play with the device.

38. If the power cord of the device is damaged, do not use the device. The power cord must be replaced by an adequate cable or assembly from an authorized service center.



CAUTION:

To reduce the risk of electric shock, do not remove cover (or back). There are no user serviceable parts inside. Maintenance and repairs should be exclusively carried out by qualified service personnel.



The warning triangle with lightning symbol indicates dangerous uninsulated voltage inside the unit, which may cause an electrical shock.



The warning triangle with exclamation mark indicates important operating and maintenance instructions.



Warning! This symbol indicates a hot surface. Certain parts of the housing can become hot during operation. After use, wait for a cool-down period of at least 10 minutes before handling or transporting the device.



Warning! This device is designed for use below 2000 metres in altitude.



Warning! This product is not intended for use in tropical climates.



Caution! Intense LED light source! Risk of eye damage. Do not look into the light source.

IMPORTANT



- The spotlight with IP65 protection class is only suitable for outdoor use when powered by the device's internal batteries and the charging socket is securely closed with the corresponding rubber sealing cap! The spotlight may not be used or charged outdoors when operated with the optionally available power supply.
- Only one spotlight may be operated in dry interior areas with the optionally available power supply and only without the corresponding 6-outlet power strip!
- The internal batteries of up to 6 spotlights may be charged in dry interior areas with the optionally available power supply and the corresponding 6-outlet power strip but all connected spotlights must be switched off!

BATTERY SAFETY



- Keep the spotlight with battery away from excessive heat and direct sunlight. Do not place it on or in heating appliances, such as microwaves, ovens or radiators. Batteries can explode if overheated.
- Do not attempt to open the spotlight and alter or modify the battery, to insert foreign materials into the battery, or to immerse it in or bring it into contact with water or other liquids. These actions could lead to a fire, explosion or other dangerous situations.
- In the event of the spotlight becoming deformed or overheating due to a battery malfunction during the charging process or during storage, immediately refrain from using the device and contact an authorised service centre. Further use of the device may result in fire or an explosion.
- Do not put the spotlight into a fire, as it could explode. Damaged batteries may also explode.
- Do not strike or puncture the spotlight, or place it under high pressure. This could lead to a short circuit or overheating.
- Do not drop the spotlight. If the device is dropped, particularly onto a hard surface, the internal battery may be damaged.
- If the battery charge life shortens significantly, please contact an authorised service centre.
- Do not attempt to remove the battery, as this could cause damage to the device. • Please contact an authorised service centre to exchange the battery.



CHARGING THE BATTERY, OPERATING AND STORING THE SPOTLIGHT

- The spotlight's internal battery may only be charged using the optionally available charging device.
- The charge time from 0% to 100% charge status is approximately 3 hours.
- After about 300 charging cycles (0–100%), the battery will retain approx. 70% of its nominal capacity.
- The electronic battery management system protects the battery from overcharge and deep-discharge.
- Charge the spotlight's battery at ambient temperatures above 0°C and below 40°C.
- Operation using the internal battery may only occur at an ambient temperature above 0°C and below 40°C.
- Charge the battery immediately after full discharge. Batteries which are not fully charged will lose capacity and their lifetime will be reduced.
- Store the spotlight only with a fully charged battery.
- If the spotlight is not used for a long time, completely recharge the battery every 6 months.
- To extend the lifetime of the battery, it is recommended that the battery is recharged as soon as possible and that it is not used until completely empty.
- In cold environments, battery life may be shorter than expected.
- Store the spotlight in cool and dry conditions to ensure optimal storage conditions for the battery.

CAUTION! IMPORTANT INFORMATION ABOUT LIGHTING PRODUCTS!

1. The product has been developed for professional use in the field of event technology and is not suitable as household lighting.
2. Do not stare, even temporarily, directly into the light beam.
3. Do not look at the beam directly with optical instruments such as magnifiers.
4. Stroboscope effects may cause epileptic seizures in sensitive people! People with epilepsy should definitely avoid places where strobes are used.

INTRODUCTION

Battery-powered outdoor spotlight with 4x 15 W RGBWA+UV LEDs and W-DMX™
CLDROPB4 / CLDROPB4WH

CONTROL FUNCTIONS

3-channel, 4-channel, 6-channel, 7-channel, 13-channel 1, 13-channel 2 and 20-channel DMX control via W-DMX™

Standalone functions

Control via IR remote control (remote control optionally available)

FEATURES

4x 15 W RGBWA+UV LEDs Outdoor housing with IP65 protection class. Mains power supply-independent operation thanks to internal Li-ion battery DMX control via W-DMX™. OLED display. Convection cooling. Removable stand and mounting bracket for inconspicuous uplighting. Tilt adjustment screw. 2 diffusers included.

Battery life when fully charged and in standard power mode	
RGBWA+UV 100%	approx. 3 h
RGBW 100%	approx. 4 h
R + G 100%	approx. 8 h
G 100%	approx. 12 h 30 min.

Battery life when fully charged and in eco power mode	
RGBWA+UV 100%	approx. 5 h 15 min.
RGBW 100%	approx. 6 h 30 min.
R + G 100%	approx. 16 h
G 100%	approx. 22 h 30 min.

ARTICLE NUMBERS

CLDROPB4(WH) – spotlight (without power supply)

CLDROPB4PS6 – power supply with 6-outlet adapter

CLDROPB4(WH)SET1 – set includes 6 spotlights plus power supply with 6-outlet adapter

CLDROPB4(WH)SET2 – set includes 6 spotlights in a case plus power supply with 6-outlet adapter

CLQSREMOTE2 – infrared remote controller

CONNECTIONS, OPERATING AND DISPLAY ELEMENTS



1 ON/OFF SWITCH

Push switch for switching the spotlight on and off.

2 OLED DISPLAY

The OLED display shows the currently activated mode (main display 1), spotlight status (main display 2 = W-DMX and battery status), the menu items in the editing menu and the numerical value or operating mode in certain menu items. Switch between both main displays by briefly pressing ENTER and DOWN at the same time. The editing menu is accessible only from main display 1. If there is no input for approx. one minute, the display automatically returns to the main display. Note on the main display in DMX operating mode: As soon as the control signal is interrupted, the characters in the display begin to flash. When there is a control signal again, the flashing stops. Briefly pressing UP in the control panel when in the main display rotates the display by 180°.

3 TOUCH-SENSITIVE CONTROLS

MENU – Press MENU to access the editing menu. Press repeatedly to go back to the main display. Pressing MENU without confirming a value or status change with ENTER restores the previously confirmed value or status.

ENTER – Press ENTER to access the menu levels, make value changes and to access the submenus with the ENTER control. Confirm value or status changes by pressing ENTER.

UP and DOWN – select individual menu items in the selection menu (DMX address, operating mode etc.) and in the submenus. Allow changes to the value in a menu item, such as the DMX address, as required.

Before changing device settings, ensure that the control panel is dry and clean, in order not to impair its functionality.

4 TILT

Knurled screw for the TILT feature for uplighting. Turn the screw outwards from the housing until you achieve the desired beam direction. The screw features a mechanical stop mechanism to prevent it from being completely removed from the housing. In order to effectively use the tilt function and achieve a more inconspicuous look, remove the mounting bracket by releasing the four screws A with a suitable tool.

5 RUBBER FEET

Four rubber feet for good stability.

6 SECURING LUG

Securing lug for attaching the spotlight on truss installations. When installing on a truss, ensure that the mounting bracket is securely attached to the spotlight housing with the four fixing screws A.

7 HANDWHEEL BOLTS

The two handle screws are used for adjusting and fixing the stand and/or mounting bracket.

8 STAND OR MOUNTING BRACKET

The stand or mounting bracket can be removed to achieve a more inconspicuous look when using the spotlight as an uplight.

9 PRESSURE EQUALISATION ELEMENT

Pressure equalisation element to prevent condensation inside the housing. In order to ensure its proper function, the element must be protected from contamination.

10 CHARGING SOCKET

Charging socket for charging the internal battery. Charging the battery is permitted only in dry interior areas. Only charge with the optionally available CLDROBP4PS6 charging device.



INFRARED SENSOR

The infrared sensor for control via IR remote control (optionally available) is found on the front of the spotlight.

OPERATION

PLEASE NOTE

- When the spotlight is switched on, the following is displayed in succession during the start-up process: “Software Update Please Wait...” (for service purposes only), “Welcome to Cameo”, the model name and the software version. After this process, the spotlight is ready for operation and the previously activated operating mode is launched.
- Main display 1 is activated automatically after approximately one minute of no input. To navigate one level up in the submenus, briefly press MENU.
- Briefly pressing UP in the control panel when in the main display rotates the display by 180°.
- To quickly change a value, such as the DMX start address, press and hold the control UP or DOWN.
- To reset and ready the W-DMX module for pairing directly from main display 1, press and hold control DOWN for around 3 seconds.

MAIN DISPLAY 1 DMX OPERATING MODE

The display shows the **DMX address** and current DMX start address (in the example: **001**).

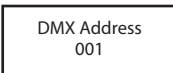

MAIN DISPLAY 1 STANDALONE MODE

The display shows the currently activated standalone mode (Mode Static, Mode Auto, Mode User Colour, Mode Colour Macro).



MAIN DISPLAY 2 FIXTURE STATUS

The display shows the W-DMX and battery status. Switch between both main displays by briefly pressing ENTER and DOWN at the same time. Main display 1 is automatically shown again after around one minute.



W-DMX™

To pair the W-DMX receiver with a W-DMX compatible transmitter, W-DMX must be activated (W-DMX On) in the receiver's menu under **Wireless Settings**. The **Reset** command must be also executed under the same menu item (select Reset and confirm with ENTER). The receiver is now in pairing standby and waiting for a pairing request from a transmitter. Start the pairing by selecting **Link** in the menu of the transmitter and then confirm; the pairing now takes place automatically. In the same way, several receivers can be paired to a transmitter either simultaneously or one after the other. A W-DMX connection is always maintained until the connection is disconnected by means of the

DMX command in the receiver or the **Unlink** command in the transmitter, regardless of whether a device has been disconnected from the power supply in the meantime.

W-DMX™ STATUS

W-DMX deactivated	W-DMX activated, not paired	W-DMX activated and paired; transmitter switched off or out of range	W-DMX activated and paired; no DMX signal	W-DMX activated and paired; DMX signal present

RF SIGNAL STRENGTH

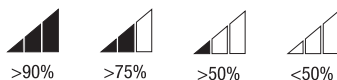

BATTERY STATUS

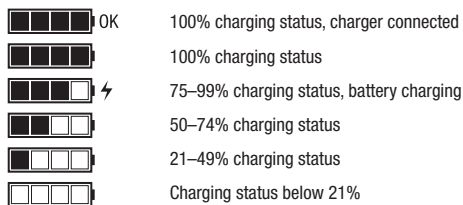

CONFIGURE DMX START ADDRESS

Starting from main display 1, press MENU to enter the main menu. Now use the controls UP and DOWN to select the menu item **DMX address** and confirm with ENTER. You can now configure the DMX start address with UP and DOWN (hold for rapid value change; highest value depends on activated DMX mode). Confirm your entry with ENTER.

Menu DMX Address DMX Mode DMX Delay Stand Alone Settings System Info	DMX Address 001 - 510
--	--------------------------

CONFIGURE DMX MODE

Starting from main display 1, press MENU to enter the main menu. Now use the controls UP and DOWN to select the menu item **DMX mode** and confirm with ENTER. Again use UP and DOWN to select the desired DMX mode and confirm with ENTER. Tables with the channel assignment of the different DMX modes can be found in these instructions under DMX CONTROL.

Menu DMX Address DMX Mode DMX Delay Stand Alone Settings System Info	DMX Mode 3 CH 4 CH 6 CH 7 CH 13CH01 13CH02 20 CH
--	---

DMX DELAY

The DMX Delay function is a simple way to create a running light effect with a large number of spotlights that are all the same model and that are all running the same software version. This is otherwise only achievable with a suitable DMX controller and time-consuming programming. All the spotlights used in this are set to the same DMX operating mode and controlled via the same DMX start address. The delay time (DMX signal delay) can be manually set on each spotlight with different delay times (DMX Delay by DMX? No) or with the same delay time for all spotlights via a connected DMX controller on a specially reserved DMX channel (DMX Delay by DMX? Yes). Starting from the main display, press MODE to enter the main menu. Now use UP and DOWN to select the menu item **DMX Delay** and confirm with ENTER. Again use UP and DOWN to select the desired submenu item, confirm with ENTER and set the value or status accordingly. Confirm all entries with ENTER.

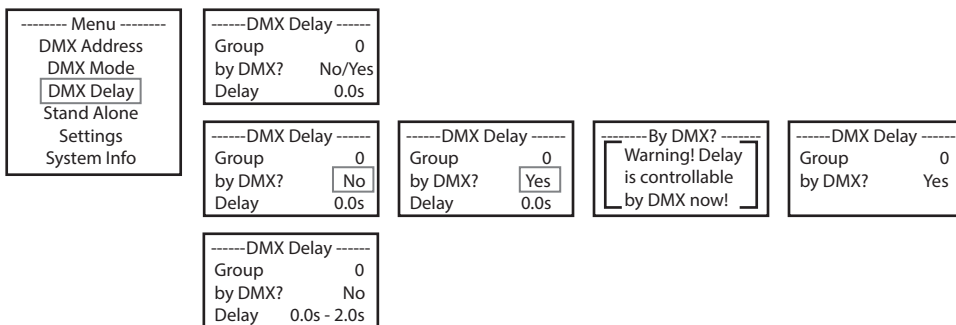

Assign the spotlights to the desired groups (maximum group number depends on the activated DMX operating mode). Multiple spotlights may be assigned to one group. The group number is also the factor by which the set delay time is multiplied (see setup example).

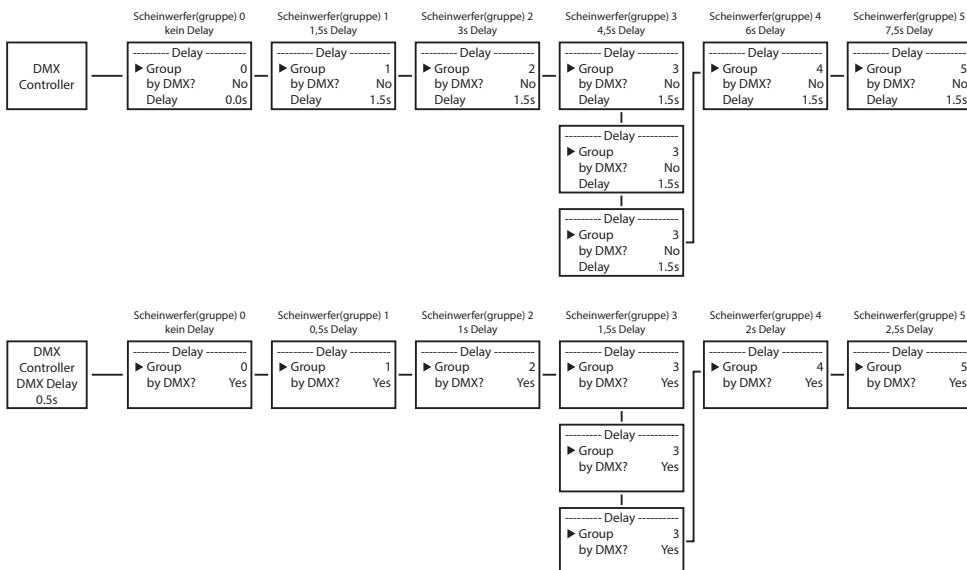

STANDALONE MODE STATIC

The standalone mode Static allows the Dimmer, Strobe, R, G, B, W, A and UV values to be set directly on the device with values between 000 and 255, in a similar way to with a DMX controller. In this way, an individual scene can be created without an additional DMX controller. Starting from main display 1, press MENU to enter the main menu. Now use the controls UP and DOWN to select the menu item **Stand Alone** and confirm with ENTER. Again use UP and DOWN to select the standalone mode **Static** and confirm with ENTER. Using UP and DOWN, now select the menu item that you wish to edit and confirm with ENTER. You can use UP and DOWN to configure the desired value between 000 and 255. The strobe effect values correspond to those in channel 2 of the DMX table 4CH and channel 3 of tables 13CH1 and 20CH. Confirm with ENTER.

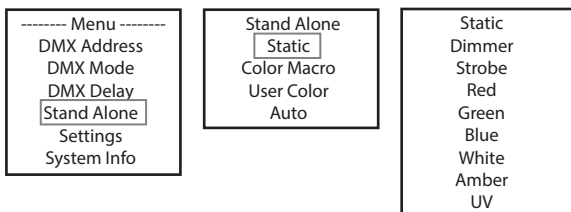

STANDALONE MODE COLOUR MACRO

15 different colour macros are available as presets. The brightness can be separately set for each preset.

Starting from main display 1, press MENU to enter the main menu. Now use the controls UP and DOWN to select the menu item **Stand Alone** and confirm with ENTER. Again use UP and DOWN to select the standalone mode **Colour Macro** and confirm with ENTER. Now use UP and DOWN to select the desired colour as a preset and confirm with ENTER (Colour Off = blackout). You can now use UP and DOWN to set the desired brightness between 000 and 100. Confirm with ENTER.

**STANDALONE MODE USER COLOUR**

The standalone mode User Colour allows you to store eight individual colour presets for overall brightness, strobe and a colour blend of R, G, B, W, A and UV directly in the device.

Starting from main display 1, press MENU to enter the main menu. Now use the controls UP and DOWN to select the menu item **Stand Alone** and confirm with ENTER. Again use UP and DOWN to select the standalone mode **User Colour** and confirm with ENTER. Using UP and DOWN, now select the desired preset (colour 1 to 8) and confirm with ENTER. Using UP and DOWN, now select the menu item that you wish to edit and confirm with ENTER. You can use UP and DOWN to configure the desired value between 000 and 255. The strobe effect values correspond to those in channel 2 of the DMX table 4CH and channel 3 of tables 13CH1 and 20CH. Confirm all entries with ENTER.

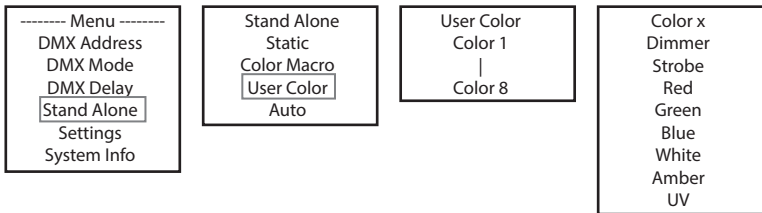
**STANDALONE MODE AUTO**

The 6 available auto-programs each comprise non-editable colour-change sequences. Brightness and speed are separately adjustable in each program.

Starting from main display 1, press MENU to enter the main menu. Now use the controls UP and DOWN to select the menu item **Stand Alone** and confirm with ENTER. Again use UP and DOWN to select the standalone mode **Auto** and confirm with ENTER. Now use the UP and DOWN to select the desired program (program 1 to 6) and confirm with ENTER. Now use UP and DOWN to select **Dimmer** or **Speed**, confirm with ENTER and set the brightness or speed value from 000 to 100 as desired. Confirm all entries with ENTER.

**SYSTEM SETTINGS (settings)**

Starting from main display 1, press MENU to enter the main menu. Use UP and DOWN to select the menu item **Settings** and confirm with ENTER.

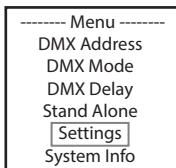

This will take you to the submenu for setting the submenu items (see table, select with UP and DOWN, confirm with ENTER, change value or status with UP and DOWN, confirm with ENTER).

Settings				
Wireless Settings	=	W-DMX settings	W-DMX On/Off	On = W-DMX enabled Off = W-DMX disabled
			Reset	Press ENTER = Reset pairing with a transmitter and ready for new pairing
Power Mode	=	Battery mode	Standard	Function disabled
			Eco	Approx. twice the battery life at 50% brightness
Display Reverse	=	Rotate display	On	Display is rotated by 180° (e.g. for overhead installation)
			Off	No display rotation
Display	=	Display lighting	On	Permanently on
			Off	Deactivation after approximately 1 minute of inactivity
DMX Fail	=	Operating status with DMX signal fault	Hold	Last command is retained
			Blackout	Activates blackout
			White	All the LEDs have 100% output
Power Fail	=	Operating status in the event of a power failure	Off	No change to current status
			On	All the LEDs have 100% output
Dimmer Curve	=	Dimmer curve	Linear	Light intensity increases linearly with DMX value
			Exponential	Light intensity can be finely adjusted at lower DMX values and broadly adjusted at higher DMX values
			Logarithmic	Light intensity can be broadly adjusted at lower DMX values and finely adjusted at higher DMX values
			S-Curve	Light intensity can be finely adjusted at lower and higher DMX values and broadly adjusted at medium DMX values
DimResp.	=	Dimmer response	LED	Lamp responds abruptly to changes in DMX value
			Halogen	Spotlight behaves like a halogen spotlight with soft brightness changes
LED Calibration	=	Colour calibration	Red, Green, Blue, White, Amber, UV	Individual colour calibration. Cross-mode brightness setting of the 6 LED groups RGBWA+UV with values from 000 to 255
Auto Lock	=	Automatic locking of the controls	On	Automatic locking of the controls after approximately 1 minute of inactivity. Display shows: "LOCKED" To unlock: press and hold UP and DOWN simultaneously for approx. 5 seconds
			Off	Automatic locking of the controls is disabled
IR Remote	=	Activate or deactivate control by IR remote control	On	IR remote control activated
			Off	IR remote control deactivated
Charge Switch	=	Activate or deactivate battery charging during operation (LEDs on)	On	When the spotlight is in operation, the battery can be charged using the optionally available charging device (max. 1 spotlight per charging device)
			Off	When the spotlight is in operation, the battery cannot be charged using the optionally available charging device (charging only possible with LED blackout)
Factory Reset	=	Reset to factory settings	Reset Now?	Resetting to factory settings: Perform reset with ENTER, cancel with MENU



Operation with the charging device or battery permitted only in dry interior areas!

SYSTEM INFORMATION (System Info)

Starting from main display 1, press MENU to enter the main menu. Now use the UP and DOWN controls to select the menu item **System Info** and confirm with ENTER.

----- Menu -----
DMX Address
DMX Mode
DMX Delay
Stand Alone
Settings
System Info

This will take you to the submenu for accessing the system information (see table, selection with UP and DOWN, confirm with ENTER, change status with UP and DOWN, confirm with ENTER).

System Info			
Firmware	=	Displays device firmware	Firmware V1.xx
Temperature	=	Displays temperature of LED unit	LED
			C/F
			Unit Celsius (= display in degrees Celsius) Unit Fahrenheit (= display in degrees Fahrenheit)
Battery Power	=	Displays battery charge (percentage)	Battery Power xxx%
Operation Hours	=	Displays operating time	Total xxxx:xxh Displays total operating time in hours and minutes

MANUAL LOCKING FUNCTION

In addition to the ability to automatically protect the lamp from accidental and unauthorised operation (see “Settings” - “Auto Lock”), the controls can also be locked manually. Press and hold the UP and DOWN controls simultaneously for approximately 5 seconds. “LOCKED” is now displayed and it is no longer possible to change the spotlight’s settings via the controls. After approx. eight minutes, the current operating mode is displayed again. To unlock, press and hold the UP and DOWN controls simultaneously for approximately 5 seconds. The display will show the previously displayed information.

IR REMOTE CONTROL (optional)

Activate infrared remote control in system settings under “IR remote” (IR Remote On). Aim the infrared remote control directly at the infrared sensor built into the front of the spotlight. The maximum range is approximately 8 metres. Deactivate infrared remote control (IR Remote Off) if you wish to control the spotlight via W-DMX.

BL / ON/OFF (Blackout)

Press the BL button to switch off all LEDs (blackout), regardless of the operating mode (enabled via remote control). Press the BL button again to reactivate the previously selected mode.

SP / SPEED

Speed setting for the colour change program in Auto Program (PG) operating mode. Select a colour change program, press the SP button then use the + and - buttons to set the desired speed from 000 to 100.

⚙️ / BRIGHTNESS

Pressing the button for setting brightness immediately activates the Static operating mode. The overall brightness can now be set using the + and - buttons (set value is shown in display).

FL / FLASH (Strobe)

Pressing the button for setting the strobe immediately activates the Static operating mode. The strobe effect can now be set using the + and - buttons. The strobe effect values correspond to those in channel 2 of the DMX table 3CH and channel 3 of tables 12CH1 and 19CH (the set value is shown in the display).

R / G / B / W / A / UV (CW and WW without function)

Individual colour mixtures can be created with the 6 buttons R, G, B, W, A and UV (static mode – static). Press the button for the desired LED colour and use the + and - buttons to set the brightness from 000 to 255 (the value is shown in the display).

Example: Set red and blue at maximum brightness, and green, white, amber and UV at minimum (i.e. off) to achieve a bright magenta colour blend.

PG (colour change program)

Select the desired colour change program 1–6 by repeatedly pressing the PG button and then set the brightness using the + and - buttons. Press the SP (Speed) button and then use the + and - buttons to set the program speed (the program, brightness and running speed are shown in the display).

CM (colour presets)

Select the desired colour preset by repeatedly pressing the CM button and then set the brightness using the + and - buttons (the colour preset and brightness are shown in the display).

SC (no function)**AU** (no function)**DIFFUSERS**

Two diffusers are supplied with the spotlight, each with a different beam angle (32°, 45°). The beam angle of the spotlight can be set at 22° (without diffuser), 32°, or 45°. Insert the desired diffuser in front of the light-emitting lens and turn it anti-clockwise like with a bayonet cap until the four outer ribs on the edge of the diffuser grip in position in their brackets in the lens hood. The four magnets in the diffuser and the four opposing magnets set into the lens hood are now directly over each other and the diffuser is securely held in place. Ensure that the side of the diffuser with the magnets set into it is facing the spotlight and that the recess in the edge of the diffuser is in the flat area of the lens hood.

INSTALLATION AND MOUNTING

Thanks to the wide stand and mounting bracket, the spotlight can be positioned in a suitable location on a level surface. Installation on a traverse is possible with a traverse clamp, which is attached to the mounting bracket (A). Suitable traverse clamps are optionally available. Ensure firm connections and secure the spotlight by attaching a suitable safety cable to the securing lug on the mounting bracket. When installing on a truss, ensure that the mounting bracket is securely attached to the spotlight housing with the four T20 Torx screws (B).



Important safety notice: Overhead mounting (especially above people) requires extensive experience, including calculation of the load limit values of the installation material, and regular safety inspection of all installation materials and spotlights. If you do not have these qualifications, do not attempt to perform an installation yourself. Refer instead to a qualified professional.



In order to effectively use the tilt function with the tilt screw when using as an uplight, and to achieve a more inconspicuous look, you must use a suitable tool to remove the mounting bracket by releasing the four T20 Torx screws (B) that secure the mounting bracket to the spotlight housing.



DMX TECHNOLOGY

DMX-512

DMX (Digital Multiplex) is the designation for a universal transmission protocol for communications between corresponding devices and controllers. A DMX controller sends DMX data to the connected DMX device(s). The DMX data is always transmitted as a serial data stream that is forwarded from one connected device to the next via the "DMX IN" and "DMX OUT" connectors (XLR plug-type connectors) that are found on every DMX-capable device, provided the maximum number of devices does not exceed 32 units. The last device in the chain needs to be equipped with a terminator (terminating resistor).



DMX CONNECTION

DMX is the common "language" via which a very wide range of types and models of equipment from various manufacturers can be connected with one another and controlled via a central controller, provided that all of the devices and the controller are DMX compatible. For optimum data transmission, it is necessary to keep the connecting cables between the individual devices as short as possible. The order in which the devices are integrated in the DMX network has no influence on the addresses. Thus the device with the DMX address 1 can be located at any position in the (serial) DMX chain: at the beginning, at the end or somewhere in the middle. If the DMX address 1 is assigned to a device, the controller "knows" that it should send all data allocated to address 1 to this device regardless of its position in the DMX network.

SERIAL CONNECTION OF MULTIPLE LIGHTS

1. Connect the male XLR connector (3-pin or 5-pin) of the DMX cable to the DMX output (female XLR socket) of the first DMX device (e.g. DMX-Controller).
2. Connect the female 3-pin XLR connector of the DMX cable connected to the first projector to the DMX input (male 3-pin socket) of the next DMX device. In the same way, connect the DMX output of this device to the DMX input of the next device and repeat until all devices have been connected. Please note that as a rule, DMX devices are connected in series and connections cannot be shared without active splitters. The maximum number of DMX devices in a DMX chain should not exceed 32 units.

The Adam Hall 3 STAR, 4 STAR, and 5 STAR product ranges include an extensive selection of suitable cables.

DMX CABLES

When fabricating your own cables, always observe the illustrations on this page. Never connect the shielding of the cable to the ground contact of the plug, and always make certain that the shielding does not come into contact with the housing of the XLR plug. If the shielding is connected to the ground, this can lead to short-circuiting and system malfunctions.

Pin Assignment

DMX cable with 3-pin XLR connectors:

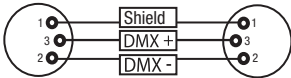

DMX cable with 5-pin XLR connectors (pin 4 and 5 are not used):

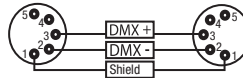

DMX TERMINATORS (TERMINATING RESISTORS)

To prevent system errors, the last device in a DMX chain needs to be equipped with a terminating resistor (120 ohm, 1/4 Watt).

3-pin XLR connector with a terminating resistor: K3DMXT3

5-pin XLR connector with a terminating resistor: K3DMXT5

Pin Assignment

3-pin XLR connector:

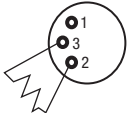

5-pin XLR connector:

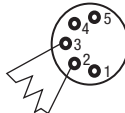

DMX ADAPTER

The combination of DMX devices with 3-pin connectors and DMX devices with 5-pin connectors in a DMX chain is possible with suitable adapters.

Pin Assignment

DMX Adapter 5-pin XLR male to 3-pin XLR female: K3DGF0020

Pins 4 and 5 are not used.

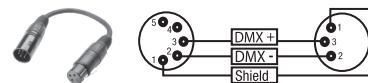

Pin Assignment

DMX Adapter 3-pin XLR male to 5-pin XLR female: K3DHM0020

Pins 4 and 5 are not used.

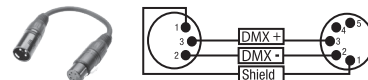

TECHNICAL DATA

ENGLISH

Product number:	CLDROPB4(WH)
Product type:	LED wash light
Type:	Outdoor spotlight
Colour spectrum LED:	RGBWA+UV
Number of LEDs:	4
LED type:	15 W Prolight LED
PWM frequency:	800 Hz
Beam angle:	Beam Angle 22° / Field Angle 38° 1. Filter Medium BA 32° 2. Filter Wide BA 45°
DMX input:	W-DMX™ (Wireless DMX)
DMX output:	–
DMX mode:	20-channel / 2 x 13-channel / 7-channel / 6-channel / 4-channel / 3-channel
DMX functions:	Dimmer, dimmer fine, RGBWA+UV fine, strobe, dimmer curves, CCT, dimmer response, colour macros, colour change, colour fading, DMX delay
Standalone functions:	Static, colour macros, auto program, user colour
Control:	W-DMX™, IR remote control (optional)
Operating controls:	Menu, Enter, Up, Down, Power
Display elements:	OLED display
Operating voltage:	100 – 240 V AC / 50 – 60 Hz
Power consumption:	75 W
Light intensity (@ 1 m/ 3 m):	6750 lx / 755 lx
Luminous flux:	1400 lm
CRI:	White LED >79
Power supply connection:	Low-voltage socket for external power supply
Ambient temperature (in operation):	0°C to 40°C
Protection class:	IP65
Power supply certificate:	CE, RoHS, ETL, FCC
Housing material:	Metal
Housing colour:	Black / white
Housing cooling:	Convection cooling (fanless)
Dimensions (W x H x D, without bracket):	170 x 170 x 186 mm
Weight:	3.1 kg
Additional features:	Included: 2x filters and 1x mounting bracket supplied Optional: 1x external power supply with 6-outlet adapter, IR remote control

DEUTSCH

FRANCAIS

ESPAÑOL

POLSKI

ITALIANO

DMX

MANUFACTURER'S DECLARATIONS

MANUFACTURER'S WARRANTY & LIMITATIONS OF LIABILITY

You can find our current warranty conditions and limitations of liability at: https://cdn-shop.adamhall.com/media/pdf/MANUFACTURERS-DECLARATIONS_CAMEO.pdf. To request warranty service for a product, please contact Adam Hall GmbH, Adam-Hall-Str. 1, 61267 Neu Anspach / Email: Info@adamhall.com / +49 (0)6081 / 9419-0.



CORRECT DISPOSAL OF THIS PRODUCT

(valid in the European Union and other European countries with a differentiated waste collection system)

■ This symbol on the product, or on its documents indicates that the device may not be treated as household waste. This is to avoid environmental damage or personal injury due to uncontrolled waste disposal. Please dispose of this product separately from other waste and have it recycled to promote sustainable economic activity. Household users should contact either the retailer where they purchased this product, or their local government office, for details on where and how they can recycle this item in an environmentally friendly manner. Business users should contact their supplier and check the terms and conditions of the purchase contract. This product should not be mixed with other commercial waste for disposal.

FCC STATEMENT

This device complies with Part 15 of the FCC Rules. Operation is subject to the following two conditions:

- (1) This device may not cause harmful interference, and
- (2) This device must accept any interference received, including interference that may cause undesired operation

CE Compliance

Adam Hall GmbH states that this product meets the following guidelines (where applicable):

R&TTE (1999/5/EC) or RED (2014/53/EU) from June 2017

Low voltage directive (2014/35/EU)

EMV directive (2014/30/EU)

RoHS (2011/65/EU)

The complete declaration of conformity can be found at www.adamhall.com.

Furthermore, you may also direct your enquiry to info@adamhall.com.

DMX CONTROL / DMX STEUERUNG / PILOTAGE DMX / CONTROL DMX / STEROWANIE DMX / CONTROLLO DMX

EN	The DMX Delay channel of each DMX mode is only enabled, if by DMX? in the menu item DMX Delay is set to Yes .
DE	Der Kanal DMX Delay ist in den DMX-Modi nur aktiviert, wenn im Menüpunkt DMX Delay unter by DMX? Yes eingestellt ist.
FR	Le canal DMX Delay de chaque mode DMX n'est activé que si par DMX ? dans le menu DMX Delay est réglé sur Yes .
ES	El canal del DMX Delay de cada modo DMX sólo está habilitado, si por DMX? en el elemento de menú DMX Delay está ajustado a Yes .
PL	Kanał DMX Delay dla każdego trybu DMX jest włączony tylko wtedy, gdy przez DMX? w punkcie menu DMX Delay ustawiony jest na Tak .
IT	Il canale DMX Delay di ogni modalità DMX è abilitato solo se alla voce di menu DMX Delay è impostato su Si .

20 CH Mode						
Ch.	Function	Values				Sub-Group
1	Dimmer	000	-	255	0% to 100%	Dimmer
2	Dimmer fine	000	-	255	0% to 100%	
3	Strobe functions	000	-	005	Strobe open	Multifunctional Strobe
		006	-	010	Strobe closed	
		011	-	033	Pulse random, slow -> fast	
		034	-	056	Ramp up random, slow -> fast	
		057	-	079	Ramp down random, slow -> fast	
		080	-	102	Random Strobe effect, slow -> fast	
		103	-	127	Strobe Break effect, 5s.....1s (short burst with break)	
		128	-	250	Strobe slow -> fast <1Hz – 20Hz	
		251	-	255	Strobe open	
4	Red	000	-	255	0% to 100%	Red
5	Red fine	000	-	255	0% to 100%	
6	Green	000	-	255	0% to 100%	Green
7	Green fine	000	-	255	0% to 100%	
8	Blue	000	-	255	0% to 100%	Blue
9	Blue fine	000	-	255	0% to 100%	
10	White	000	-	255	0% to 100%	White
11	White fine	000	-	255	0% to 100%	
12	Amber	000	-	255	0% to 100%	Amber
13	Amber fine	000	-	255	0% to 100%	
14	UV	000	-	255	0% to 100%	UV
15	UV fine	000	-	255	0% to 100%	

ENGLISH

DEUTSCH

FRANCAIS

ESPAÑOL

POLSKI

ITALIANO

DMX

16	Color Macros (override RGBWA+UV)	000	-	005	Color off	Color Macros
		006	-	013	Red	
		014	-	021	Amber	
		022	-	029	Yellow warm	
		030	-	037	Yellow	
		038	-	045	Green	
		046	-	053	Turquoise	
		054	-	061	Cyan	
		062	-	069	Blue	
		070	-	077	Lavender	
		078	-	085	Mauve	
		086	-	093	Magenta	
		094	-	101	Pink	
		102	-	109	Warm White	
		110	-	117	White	
		118	-	125	Cold White	
		126	-	127	Color Jumping stop	
		128	-	164	Color Jumping speed slow -> fast	
		165	-	201	Color Fading speed slow -> fast	
		202	-	207	User Color_1	
208	-	213	User Color_2			
214	-	219	User Color_3			
220	-	225	User Color_4			
226	-	231	User Color_5			
232	-	237	User Color_6			
238	-	243	User Color_7			
244	-	249	User Color_8			
250	-	255	no function			
17	Color Macro Cross-fade (transition time between Color Macros)	000	-	005	0s	Transition Time between Color Macros
		006	-	105	0.1s – 10s (0.1s Steps)	
		106	-	214	11s – 119s (1s Steps)	
		215	-	244	2m – 4m50s (10s Steps)	
		245	-	255	5m – 15m (1m Steps)	
18	Color Temperature (overrides RGBWA+UV and Color Macros)	000	-	006	off	CCT
		007	-	009	Bulb White (2700K)	
		010	-	012	Halogen White (3200K)	
		013	-	015	Neutral White (4000K)	
		016	-	018	Studio White (5600K)	
		019	-	021	Daylight White (6500K)	
		022	-	255	1800K – 7500K	

19	Device Settings (please read remark 1*)	000	-	005	no function	Control
		006	-	073	Spare	
		074	-	075	Dimmer Response LED (hold 3s)	
		076	-	077	Dimmer Response Halogen (hold 3s)	
		078	-	139	Spare	
		140	-	141	Display on (hold 3s)	
		142	-	143	Display off (hold 3s)	
		144	-	163	Spare	
		164	-	165	Dimmer Curve Linear (hold 3s)	
		166	-	167	Dimmer Curve Exponential (hold 3s)	
		168	-	169	Dimmer Curve Logarithmic (hold 3s)	
		170	-	171	Dimmer Curve S-Curve (hold 3s)	
		172	-	191	Spare	
		192	-	193	Full Power Mode (hold 5s)	
		194	-	195	Eco Mode (\approx 50% LED Power) (hold 5s)	
		196	-	197	Spare	
198	-	199	Spare			
200	-	201	Spare			
202	-	255	Spare			
20	DMX Delay	000	-	005	No Delay	DMX Delay
		006	-	255	0.1s -> 2.0s	

EN: (1*) After the adjustments have been made, set the value to 000 to avoid disturbance by endless function call.

DE: (1*) Nachdem die Einstellungen vorgenommen wurden, stellen Sie den Wert auf 000 ein, um Störungen durch endlosen Funktionsaufruf zu vermeiden.

FR: (1*) Une fois les ajustements effectués, réglez la valeur sur 000 pour éviter les perturbations par appel de fonction sans fin.

ES: (1*) Después de realizar los ajustes, establezca el valor en 000 para evitar perturbaciones mediante una llamada de función sin fin.

PL: (1*) Po dokonaniu ustawień ustaw wartość na 000, aby uniknąć zakłóceń przez niekończące się wywołanie funkcji.

IT: (1*) Dopo aver effettuato le regolazioni, impostare il valore su 000 per evitare disturbi causati da una chiamata a funzione infinita.

13 CH Mode						
Ch.	Function	Values				Sub-Group
1	Dimmer	000	-	255	0% to 100%	Dimmer
2	Dimmer fine	000	-	255	0% to 100%	
3	Strobe functions	000	-	005	Strobe open	Multifunctional Strobe
		006	-	010	Strobe closed	
		011	-	033	Pulse random, slow -> fast	
		034	-	056	Ramp up random, slow -> fast	
		057	-	079	Ramp down random, slow -> fast	
		080	-	102	Random Strobe effect, slow -> fast	
		103	-	127	Strobe Break effect, 5s.....1s (short burst with break)	
		128	-	250	Strobe slow -> fast <1Hz – 20Hz	
251	-	255	Strobe open			
4	Red	000	-	255	0% to 100%	Red
5	Green	000	-	255	0% to 100%	Green
6	Blue	000	-	255	0% to 100%	Blue
7	White	000	-	255	0% to 100%	White
8	Amber	000	-	255	0% to 100%	Amber
9	UV	000	-	255	0% to 100%	UV

10	Color Macros (override RGBWA+UV)	000	-	005	Color off	Color Macros
		006	-	013	Red	
		014	-	021	Amber	
		022	-	029	Yellow warm	
		030	-	037	Yellow	
		038	-	045	Green	
		046	-	053	Turquoise	
		054	-	061	Cyan	
		062	-	069	Blue	
		070	-	077	Lavender	
		078	-	085	Mauve	
		086	-	093	Magenta	
		094	-	101	Pink	
		102	-	109	Warm White	
		110	-	117	White	
		118	-	125	Cold White	
		126	-	127	Color Jumping stop	
		128	-	164	Color Jumping speed slow -> fast	
		165	-	201	Color Fading speed slow -> fast	
		202	-	207	User Color_1	
		208	-	213	User Color_2	
		214	-	219	User Color_3	
		220	-	225	User Color_4	
		226	-	231	User Color_5	
		232	-	237	User Color_6	
238	-	243	User Color_7			
244	-	249	User Color_8			
250	-	255	no function			
11	Color Macro Crossfade (transition time between Color Macros)	251	-	005	0s	Transition Time between Color Macros
		006	-	105	0,1s – 10s (0,1s Steps)	
		106	-	214	11s – 119s (1s Steps)	
		215	-	244	2m – 4m50s (10s Steps)	
		245	-	255	5m – 15m (1m Steps)	
12	Color Temperature	000	-	006	off	CCT
		007	-	009	Bulb White (2700K)	
		010	-	012	Halogen White (3200K)	
		013	-	015	Neutral White (4000K)	
		016	-	018	Studio White (5600K)	
		019	-	021	Daylight White (6500K)	
		022	-	255	1800K – 7500K	
13	DMX Delay	000	-	005	No Delay	DMX Delay
		006	-	255	0.1s -> 2.0s	

13 CH Mode 2						
Ch.	Function	Values				Sub-Group
1	Red	000	-	255	0% to 100%	Red
2	Red fine	000	-	255	0% to 100%	
3	Green	000	-	255	0% to 100%	Green
4	Green fine	000	-	255	0% to 100%	
5	Blue	000	-	255	0% to 100%	Blue
6	Blue fine	000	-	255	0% to 100%	
7	White	000	-	255	0% to 100%	White
8	White fine	000	-	255	0% to 100%	
9	Amber	000	-	255	0% to 100%	Amber
10	Amber fine	000	-	255	0% to 100%	
11	UV	000	-	255	0% to 100%	UV
12	UV fine	000	-	255	0% to 100%	
13	DMX Delay	000	-	005	No Delay	DMX Delay
		006	-	255	0.1s -> 2.0s	

7 CH Mode						
Ch.	Function	Values				Sub-Group
1	Red	000	-	255	0% to 100%	Red
2	Green	000	-	255	0% to 100%	Green
3	Blue	000	-	255	0% to 100%	Blue
4	White	000	-	255	0% to 100%	White
5	Amber	000	-	255	0% to 100%	Amber
6	UV	000	-	255	0% to 100%	UV
7	DMX Delay	000	-	005	No Delay	DMX Delay
		006	-	255	0.1s -> 2.0s	

6 CH Mode						
Ch.	Function	Values				Sub-Group
1	Dimmer	000	-	255	0% to 100%	Dimmer
2	Strobe	000	-	005	Strobe open	Strobe
		006	-	255	Strobe slow -> fast <1Hz – 20Hz	
3	Chase (chase between Color Macro 1 and Color Macro 2)	000	-	005	No Chase, Color Macro 1 is on	Chase
		006	-	026	Jump 10,0s -> 4,0s	
		027	-	127	Jump 4,0s -> 0,1s	
		128	-	148	Fade 10,0s -> 4,0s	
		149	-	255	Fade 4,0s -> 0,1s	

4	Color Macros 1	000	-	005	Color off	Color Macros 1
		006	-	013	Red	
		014	-	021	Amber	
		022	-	029	Yellow warm	
		030	-	037	Yellow	
		038	-	045	Green	
		046	-	053	Turquoise	
		054	-	061	Cyan	
		062	-	069	Blue	
		070	-	077	Lavender	
		078	-	085	Mauve	
		086	-	093	Magenta	
		094	-	101	Pink	
		102	-	109	Warm White	
		110	-	117	White	
		118	-	125	Cold White	
		126	-	201	no function	
		202	-	207	User Color_1	
		208	-	213	User Color_2	
214	-	219	User Color_3			
220	-	225	User Color_4			
226	-	231	User Color_5			
232	-	237	User Color_6			
238	-	243	User Color_7			
244	-	249	User Color_8			
250	-	255	no function			
5	Color Macros 2	000	-	255	same like Color Macros 1	Color Macros 2
6	DMX Delay	000	-	005	No Delay	DMX Delay
		006	-	255	0,1s -> 2,0s	

4 CH Mode						
Ch.	Function	Values				Sub-Group
1	Dimmer	000	-	255	0% to 100%	Dimmer
2	Strobe functions	000	-	005	Strobe open	Multifunctional Strobe
		006	-	010	Strobe closed	
		011	-	033	Pulse random, slow -> fast	
		034	-	056	Ramp up random, slow -> fast	
		057	-	079	Ramp down random, slow -> fast	
		080	-	102	Random Strobe effect, slow -> fast	
		103	-	127	Strobe Break effect, 5s.....1s (short burst with break)	
		128	-	250	Strobe slow -> fast <1Hz – 20Hz	
251	-	255	Strobe open			

3	Color Macros	000	-	005	Color off	Color Macros
		006	-	013	Red	
		014	-	021	Amber	
		022	-	029	Yellow warm	
		030	-	037	Yellow	
		038	-	045	Green	
		046	-	053	Turquoise	
		054	-	061	Cyan	
		062	-	069	Blue	
		070	-	077	Lavender	
		078	-	085	Mauve	
		086	-	093	Magenta	
		094	-	101	Pink	
		102	-	109	Warm White	
		110	-	117	White	
		118	-	125	Cold White	
		126	-	127	Color Jumping stop	
		128	-	164	Color Jumping speed slow -> fast	
		165	-	201	Color Fading speed slow -> fast	
		202	-	207	User Color_1	
208	-	213	User Color_2			
214	-	219	User Color_3			
220	-	225	User Color_4			
226	-	231	User Color_5			
232	-	237	User Color_6			
238	-	243	User Color_7			
244	-	249	User Color_8			
250	-	255	no function			
4	DMX Delay	000	-	005	No Delay	DMX Delay
		006	-	255	0.1s -> 2.0s	

3 CH Mode						
Ch.	Function	Values				Sub-Group
1	Dimmer	000	-	255	0% to 100%	Dimmer
2	Color Temperature	000	-	006	off	CCT
		007	-	009	Bulb White (2700K)	
		010	-	012	Halogen White (3200K)	
		013	-	015	Neutral White (4000K)	
		016	-	018	Studio White (5600K)	
		019	-	021	Daylight White (6500K)	
		022	-	255	1800K – 7500K	
3	DMX Delay	000	-	005	No Delay	DMX Delay
		006	-	255	0.1s -> 2.0s	

