



EventPlayer mkII



Show controller Audio and DMX player EP220 et EP230

MANUAL

Table of contents

A - Safety instructions.....	P1
B - Product information.....	P3
1 - Product presentation	P4
2 - Functionalities	P4
3 - Installation	P5
4 - Operation mode and naming of files	P10
5 - Menu and configuration.....	P21
6 - Show control and DMX link	P23
7 - Timestamped Programming control (Scheduler).....	P25
8 - Auxiliary input	P27
9 - Serial RS-232 Protocol.....	P28
10 - Ethernet Link	P32
11 - Firmware update.....	P35
12 - Reset Factory.....	P35
Annexe A - Specifications	P36
Annexe B : Infrared remote control.....	P37

ID-AL products are exclusively manufactured by Waves System

LA VILLE EN BOIS - 44830 BOUAYE - FRANCE

Sales and information: +33 2 40 78 22 44

E-mail : info@id-al.com

Web site: <http://www.id-al.com> and www.wsystem.com

Technical department : support@wsystem.com

Technical support :

For a detailed list of the technical support options, we suggest you to visit our site www.id-al.com.

Information in this manual is subject to change without notice and do not represent any commitment from Waves System. The equipment described in this manual is supplied under condition of the terms of license specifying the legal use conditions. This manual can't be reproduced or used, in whole or in part, in any form and by any mean, for other use than private, without the written permission from Waves System.

ID-AL is a trademarks of Waves System.

ACAUTION! DO NOT EXPOSE TO HUMIDITY & DUST!

Unplug the power supply cable before any servicing

FOR YOUR SAFETY, PLEASE READ THE USER'S GUIDE CAREFULLY BEFORE OPERATING YOUR PLAYER.

A. SAFETY INSTRUCTIONS

A.1 CE marking

The CE marking is found on the nameplate, at the rear side of the device. It certifies the conformance of the device with the low voltage CE Directive, according to the EN 55022 standard, and the Electromagnetic Compatibility Directive 61000-4-x.

A.2 Directives

- The requirements related to the electromagnetic compatibility and low voltages directive are met.

A.3 Overview

- The user manual is an integral part of the product. It must always be kept handy & close by. Proper usage conforming to the product intended purpose involves strict compliance with the instructions given in this manual.

In the event of return of the equipment, the user manual should be handed over to the new purchaser. The staff should receive instructions concerning the proper usage of the device.

- Only usage of genuine parts ensures perfect safety for the user and correct operation of the device. Moreover, only accessories mentioned in the technical documentation or explicitly approved by the manufacturer must be used. In the event of usage of accessories or consumable products from other brands, the manufacturer cannot stand guarantee for the correct and safe operation of the device.

- Damages caused through usage of accessories or consumable products from other brands will not entail right to any benefit under the terms of warranty.

- The manufacturer will be liable for the safety, reliability and functioning of the product as long as the assembly, settings, modifications, extensions and repairs have been carried out by the manufacturer or a company approved by the manufacturer and if the device is used in accordance with the instructions mentioned in this manual.

- The player complies with the technical safety standards in force at the date of print of this manual. All rights reserved for the electrical diagrams, procedures, names and devices mentioned herein.

- Any reproduction of the technical documentation, even partially, without the written authorization from Waves System is prohibited.

A.4 General Safety instructions

This device has been shipped out from our facilities in perfect working condition. In order to preserve these conditions, for safety and to avoid any risk of accidental bodily injury, the user must imperatively follow the safety instructions and read the 'Caution!' messages included in this manual.

This device, made by Waves System, has been designed in a way that practically eliminates any risk if it is used in accordance to its intended purpose. Nevertheless, with a concern for safety, we would like to draw your attention to the following instructions:

- When using the device, comply with all local rules and regulations in force. Any modification or conversion of the device automatically entails loss of the homologation. The operation of a modified device is liable to a penalty. In the interest of occupational safety, the operator and the user are held responsible for complying with the regulations.
- Keep the original packing for a possible product re-shipment. Also ensure to keep the packing material out of children's reach. Only this original packing ensures optimal protection for the product during transportation. If a product reshipment appears to be necessary during the guarantee period, Waves System is not liable for any ensuing damages arising during the transportation and attributable to a defective packing.
- This device is used to broadcast video and audio files. It should be used only by persons whose training or knowledge ensures proper handling.
- Before every use, the operator must check that the device is in perfect working condition.
- This product must not be used in places where there is a potential explosion risk. Besides, it must neither be used in an environment favouring combustion nor in a humid or excessively hot or cold location.

A.5 Safety instructions against risks due to electric currents

- The device must be connected to a grounded AC power outlet or a European standard outlet installed as per good professional practices.
- Before connecting the device, check that the power supply voltage and frequency match the specifications indicated on the device.
- Before powering, check that the device and cables are not damaged. Damaged cables and connections must immediately be replaced.
- Never allow the power cords to come in contact with other cables. Handle the power supply cable as well as all other cables connected to the mains with extreme care.
- Always connect the plug-in connector in the end. Ensure that the On/Off switch is in 'Off' position before connecting the device to the mains. The mains outlet must remain accessible after the installation.
- Check the device and its power supply cable from time to time. Disconnect the device from the mains when it is no longer used or for the purpose of maintenance.
- Handle the power cord by using the plug-in connector only. Never remove the plug-in connector by pulling the power cord.
- Electrical connection, repairs and maintenance must be carried out by qualified personnel.
- Do not switch on or switch off the device within a short span of time as this will reduce equipment life.

A.6 - Terms of use:

- This product has been designed for indoors use only.
- If this device has been exposed to very high temperature fluctuations (e.g.: after transportation), do not connect it immediately. The condensation formed inside the device could damage it. Allow the device to attain ambient temperature before connecting it.
- Do not shake the device, avoid sudden movements during its installation or handling.
- When selecting the spot for installation of the player, ensure that it is not exposed to a high source of heat, humidity or dust. There should not be any cables lying around as they might jeopardise your & others safety.

B. PRODUCT INFORMATION

B.1 Correct usage

The player is used to broadcast audio/video files automatically.

Correct usage involves compliance with the instructions given in this manual as well as with the requirements concerning installation.

B.2 Incorrect usage

Any other usage or usage beyond the scope of this application is considered as incorrect usage. The manufacturer shall not be liable for the damages ensuing from it. The user shall bear full responsibility for the risks incurred.

B.3 Delivery details

EventPlayer EP220 or EP230

External power supply and its power supply cable

Infrared remote control

User's manual

B.4 Specifications

Audio/video Player model : EP220 or EP230

Nominal electrical values of the power supply connection

Voltage (V) 100 to 240

Frequency (Hz) 50-60

For details see Annexe B

B.5 Installation

The device must be installed in a dust free area.

Do not install the device directly against a wall. To avoid overheating, the ventilation openings must not be blocked. Take care to leave an empty space above the ventilation slits.

B.6 Electrical connection

Before activation, check whether the mains voltage matches with the voltage indicated on the rating plate.

1 - Introduction

EventPlayer mkII is an audio and DMX player providing Show Control function. The files are stored on a microSD Card or USB flash memory device. This standalone player can read files automatically according to a broadcast schedule or upon triggering by external events.

The Show Control function consists of sending commands to the 8 output contacts, programmed values to the DMX channels or/and instructions through the serial link in synchronisation with the audio.

EventPlayer is used in sound & light shows, event driven industry, monuments displays, audio automation and integration projects for museums, exhibitions, retail, theme parks & tourist attractions...

2 - Features

Interactivity: EventPlayer is an interactive player.

- Broadcast pattern defined by file names
- Electrical contacts: 8 inputs combinable up to 255 inputs to trigger files through sensors, push-buttons, relays ...
- Commands through the RS-232 serial link. A simple protocol is used to send commands to the player.
- Commands via a web page through the Ethernet link.
- Time programming. Integrating an real time clock, the player broadcasts files according to a schedule created using the «ID-AL Scheduler» software.
- An built-in infrared sensor allows remote control (optional external infrared sensor - EP230)

Show Control : EventPlayer mkII reads audio files and events files in the same time (sync). The events are command to the outputs:

- DMX Data on the XLR output to peripheral (dimmer, LED device , moving heads....)
- 8 output contact to control relays, motors, lamps...

Autoplay: EventPlayer starts automatically on powering on. This feature is programmable and can be disabled.

Playback: The audio files are stored on a SD card or an external USB device. The playback pattern is defined by file & directory names.

Audio input: The player offers a line level auxiliary audio input. The input is switchable through triggering and programming. The player acts like a message box inserted in an existing sound system. A Fade in/ out is programmable to ensure a smooth transition.

RS-232 serial link: EventPlayer mkII can receive/send data from/to an external device.

Ethernet link: The player can be controlled by Ethernet network. (html web server) and the media could be updated using FTP transfer.

3 - Installation



- 1 - microSD
- 2 - DMX output
- 3 - LCD display
- 4 - Volume and menu
- 5 - Activity LED
- 6 - Infrared sensor

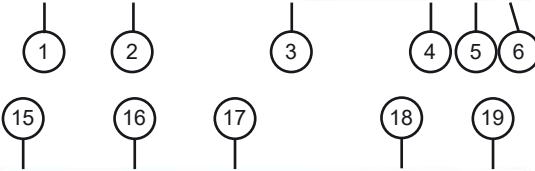

- EP230 Only**
- 15 - External infrared sensor
 - 16 - USB Device
 - 17 - 8 inputs contact
 - 18 - 8 outputs contact
 - 19 - 5v power output



- EP220 and EP230**
- 7 - Auxiliary audio input
 - 8 - Line audio output
 - 9 - Amplified speaker output
 - 10 - Input contact
 - 11 - RS-232 link
 - 12 - Ethernet link
 - 13 - USB Flash memory connector
 - 14 - power supply

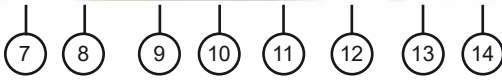

First use: EventPlayer mkII are factory setting configured with parameters by default and the player must operate on inserting a prepared media dedicated to.

1 - Insert a prepared microSD or USB flash memory.



OR

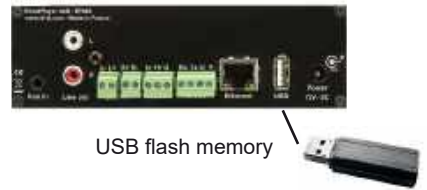

Note : If you connect a microSD card and a USB flash memory, microSD will be used not the USB

2 - Connect speakers or a sound system to the audio output, the PSU and switch on the player

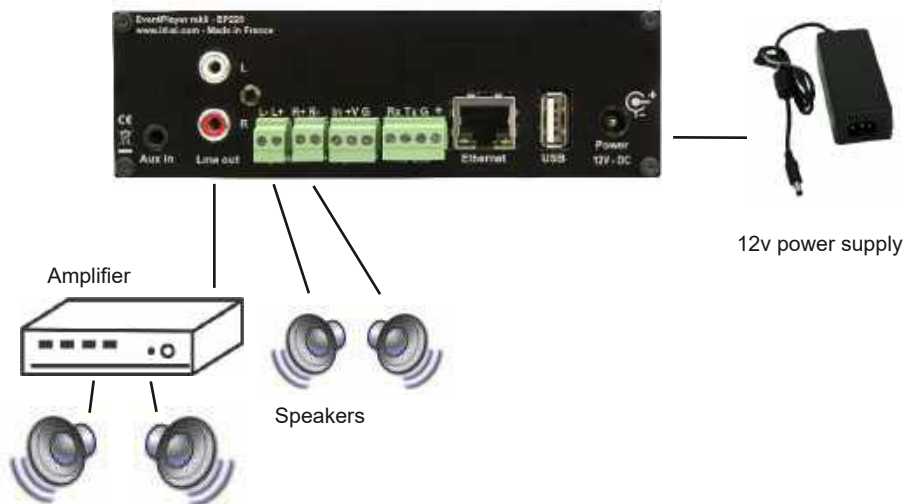

Power Supply Unit: We recommend you to use the PSU provided with the player. If you use another PSU, you have to respect the 12V specified voltage although the player can be power supplied between 10V and 15V. The power consumed depends on the power level of the amplifier.

Preparation of the medias:

Brand new USB flash drive or micr SD card are usually «FAT32» formatted.

Other types of formatting do not work.

SD/SDHC or microSD/SDHC cards have a limit to 32GB due to the specifications of the SDHC standard.

The SDXC card are not supported

If you use Windows PC computer, latest versions do not allow to format high capacity medias(>32Go) system FAT32. In this case you must obtain a formatting software. Many softwares are available, some free, others payable that you will easily find on internet.

3.1 - Connections

Connection is directly from the sensor/push button to the player trigger input.

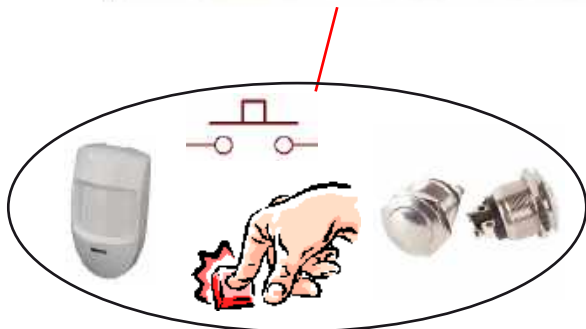

Internal input schematic

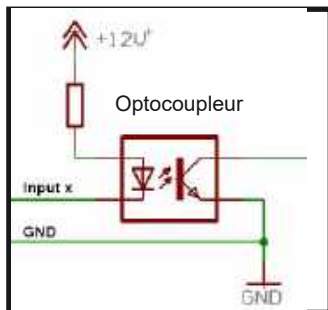

- In - Trigger input
- +V - power supply output for an external peripheral device
- G - Ground

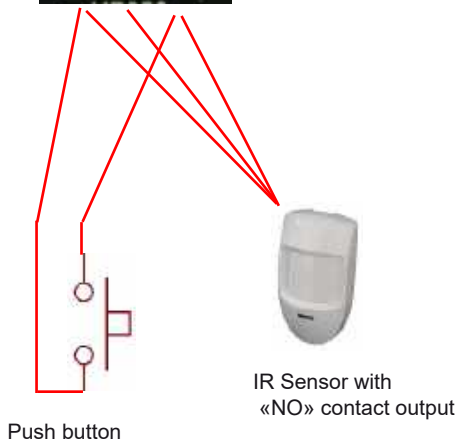

Note: +12v is a transfer of the main external PSU. The provided power will not exceed 500mA.

3.2 - Connexions - 8 input - EP230 only

Up to 8 inputs, the connections are direct. Over 8 inputs, you need to make a combination using diodes or other electronic system according to binary combination.

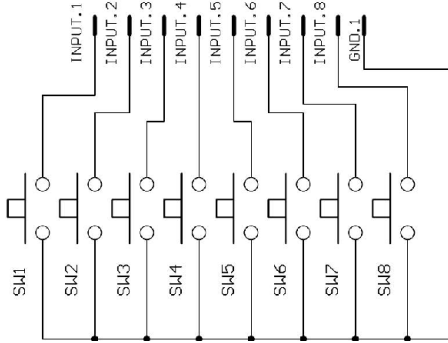

Relation from 8 input to folders name:

- SW1 = Folder 001
- SW2 = Folder 002
- SW3 = Folder 004
- SW4 = Folder 008
- SW5 = Folder 016
- SW6 = Folder 032
- SW7 = Folder 064
- SW8 = Folder 128

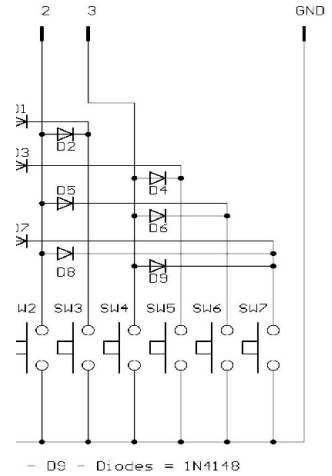

Relation of 3 inputs combination and folder name:

- SW1 = Folder 001
- SW2 = Folder 002
- SW3 = Folder 003
- SW4 = Folder 004
- SW5 = Folder 005
- SW6 = Folder 006
- SW7 = Folder 007

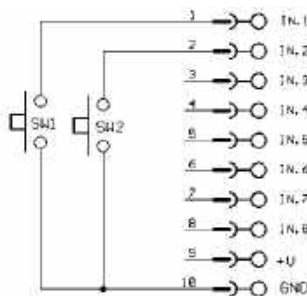

Example to play folder 001 or 002

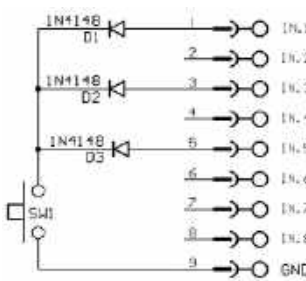

Example of combination to play folder 021

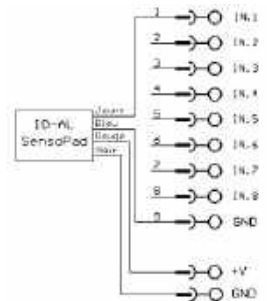

Example for use SensoPad powered by the player to play folder 001

3.3 - Contact output - EP230 Only

The EP230 player can control an output contact to switch on/off some peripherals like LEDs, small motors, relays... The output is setup (on/off) by the name of the folder.

The contact output is an electronic switch named «MOSFET». (see schematic). You can control up to 60V / 500mA max device. You can't control device with high power. In this case, you need to use a relay.

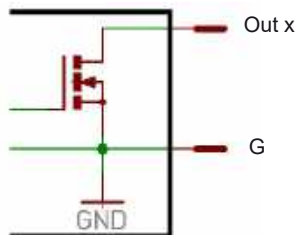

Output schematic

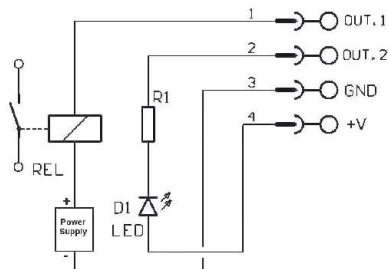

Example of a connection to control a LED in direct or a relay with an external power supply.



Note: +V is a transfer of the main external PSU. The provided power will not exceed 500mA.



You can use the 5V output to power an external peripheral. Max 1A.

4 - Operating mode

Compatibles files:

.MP3: audio files MP3 format (see appendix B)

.WAV: audio filesWav format (see appendix B)

The file and folders names define the playback mode. The files and folders must be stored and copied according to a specific organisation described below.

4.1 Organisation of the folders:

Only ONE folder level is allowed at the root. The folder names are composed of 3 digits (000 to 999) followed by optional parameters and the name of your choice.

You should not use special or accentuated characters

Example :

001

003 [J002]

034 folder name

247 [V+02] [SEQ] my folder

The folder number identifies the folder to use at the power on of the player, during a jump or an input triggering. You can use any number between 000 & 999.

● The first three digits represent the folder number and therefore its main name

Folders are numbered from 000 to 999.

Example :

000 : Folder N°000 - «Autoplay» folder which is automatically played when the device is powered on.

001 : Folder N° 1

034 : Folder N° 34

The folder number is used to define the playback order, it identifies the folder to use during a jump or an input triggering. You can use any number between 000 & 999.

IMPORTANT : The 4 input contacts allow the triggering of the folders numbers corresponding to these 3 digits, as per a binary order from 001 to 015. It is possible to modify the numbers of the triggered folders by editing file config.txt. (See chapter 5).

Folder 001- > Input 1

Folder 002 - >Input 2

Folder 003- > Input 1+2

Folder 004- > Input 3

Folder 005- > Input 1+3

Folder 006- > Input 2+3

Folder 007- > Input 1+2+3

Folder 008 - >Input 4

Folder 009 - >Input 1+4

Folder 010 - >Input 2+4

Folder 011 - >Input 1+2+4

Folder 012 - >Input 3+4

Folder 013 - >Input 1+3+4

Folder 014 - >Input 2+3+4

Folder 015 - >Input 1+2+3+4

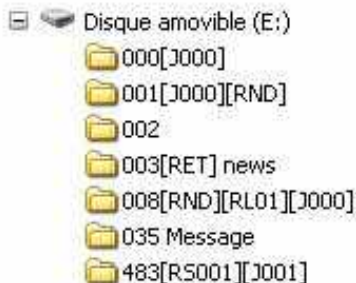

Special case: Folder 000 is the folder which will be played by default when powering on. When powering on, presence of this folder is checked ; if it is present, the player plays files of this folder. If this folder is missing, the player turns in to stop mode.

Note: The folder which is read by default when powering on can be modified in the configuration menu. (see chapter 5)

Additional Parameters - Optional Tags:

To modify the conduct of the player, you can add optional parameters within the folder name. These parameters are boxed with the symbols «[« »]». You can add several parameters within the folder name.

[Jxxx] - Jump to another folder after reading the current folder or play in loop

[RET] - Returns to the previous folder after reading the current folder

[RND] ou **[SEQ]** - Specifies random or sequential playback mode for the current folder

[V+xx] ou **[V-xx]** - Controls the volume level of the folder

[NT] – Define interruption modes

[RSxxx] – Sending of RS232 codes

[WHL] - Play the folder during all the time that the corresponding inputs is activated

[NXTxxx] - Play a defined number of audio files from the folder

[AUX] - Select the auxiliary input after reading the current folder

EP230 only:

[Rxxx] - Active or deactivate the outputs contacts when play folder

Note: If no optional parameter has been indicated, the player reads randomly the folder in full and then stops. The folder can be interrupted

● **[Jxxx]** - Jump to the Folder xxx at the End of the Playback of the Folder

This tag defines the behavior at the end of the playback of the folder. It indicates the 3-digit number (xxx from 000 to 999) of the next folder to play, which can also be the number of the folder itself in order to play it in a loop. By default, if this tag is missing, the playback stops at the end of the folder.

Example :

001 [J002] Jump to folder 002 after playing folder 001.

003 [J003] Jump to folder 003 after playing folder 003 -> create a loop of the 003 folder.

008 [J023] Jump to folder 023 after playing folder 008.

458 [J999] Jump to folder 999 after playing folder 458.

To play in a loop some audio files on startup, the folder 000 must be used and tagged with [J000]

● **[RET]** - Return to the Previous Folder at the End of the Playback of the Folder

During the playback of a folder, if an event or a tag instructs to play another folder tagged with [RET], then the player jumps to the new folder. At the end of the playback of this new folder, the player jumps back to the initial folder.

This function can be used to resume the playback of a folder interrupted by the playback of a message triggered by an event.

Example:

001 [J100]	After the folder 001 playback, jump to the folder 100.
002 [J100]	After the folder 002 playback, jump to the folder 100.
100 [RET]	After the folder 100 playback, return to the previous folder (001 or 002).

In the above example, after the playback of the folder 001 or 002, the folder 100 is played, then the player jumps back to the initial folder (001 or 002).

Note: The [RET] tag has only one level of return, i.e. the target folder is always the previously played folder, whatever the number of folders tagged with [RET] played in a row.

● [SEQ] or [RND] - Sequential or Random Playback Mode

By default, without this parameter, the folder is played in random mode.

[SEQ]: playback the files of the folder, in numerical ascending order

[RND]: playback in a random order.

Example:

001[SEQ]	Play the folder 001 in sequential mode, then stop.
002[RND][J002]	Play the folder 002 in random mode and in a loop.
003[J001]	Play the folder 003 in random mode, then jump to the folder 001.

By choosing [SEQ] you select the sequential mode, meaning a reading in a defined order. The sorting is made through a numerical order it has to say in the order of the numeros of the names of the files. The files in the folder can be numbered from 001 to 999.(see next chapter related to files organisation within the folders for the naming details).

In a defined order [SEQ], the files which are not numbered are ignored.

● [V+xx] ou [V-xx] – Volume folder setting

The name of the folder can act on the output volume. This function is used to broadcast messages loud more or less than others files.

The increase or decrease of the volume by the volume tags is always done relatively the main volume. The xx parameter of the tag [V+xx] and [V-xx] is the number of volume steps to increase or decrease the main volume. It is always written with 2 digits (example: 01, 32, 64). It is between 00 and 64.

Example :

001[V+05]:	increase the volume level from 5 steps during the folder playback
001[V-03] :	decrease the volume level form 3 steps during the folder playback

At the end of the reading of the folder, the volume level goes back to its previous level.

- If the variation values exceed the minimum or maximum values of the player, the levels are settled to their maximum or minimum.

- **[NT]** - This option defines the interruption mode of the folder currently read.

If this option is registered in the folder name, the read file cannot be interrupted and instructions received are ignored.

Without this option, the reading of the currently read folder can be interrupted at any time by an external action. (input, RS232 ...)

Example:

001 [NT] - The folder can NOT be interrupted.

In that case, an action on one of the input contacts, through RS232 or other is ignored and the reading of the current file is not stopped. Caution! The action is not memorised and the triggering information is lost.

Note: the [NT] tag work exclusively on the change folder commands. The PLAY, STOP, NEXT FILE or PREVIOUS FILE commands are immediately executed.

- **[RSxxx]** – This tag allows to send bytes onto the RS232 output.

When the folder is called, a list of bytes is transferred by the serial link in order to control other devices (another player, switching grid, projector, ..) The bytes to send are included in a text file that will be especially created for.

Value by default : 19200 Bauds - 8 bits – no parity – 1 bit start – 1 bit stop

(modifiable through the config.txt file)

The xxx parameter of the tag [RSxxx] is the number of serial command to send (number of the line in the «serial.txt» file). It is always written with 3 digits (example: 001, 045, 999). It is between 001 and 999.

The file definition of the bytes to send must be named : serial.txt

This file will be copied at the root of the media (memory card/flash drive)

This file is a text file (raw text without page setting) that can be created with any easy text editor like «notepad» from windows or similar. When saving, use «ANSI» coding. Do not use special characters.

The file «serial.txt» of RS232 codes is a text file containing one or several lines. Each of these lines will include a sequence of bytes expressed in hexadecimal and separated by a space (from 00h to FFh). You must only indicate the two characters of the wished hexadecimal value.

Each beginning of line of this file should present the following parameter:

#xxx : the xxx number of the line containing the bytes to send related to the xxx of the tag.

[RS002]-> line #002 – the tag [RS002] will send the sequence of bytes of the line #002 of the serial.txt file.

The separator between each byte is a space.

Example of a line contained in the serial.txt file.

#001: 45 85 63 21 78 A5 B2

#002: 98 75 21 35 45 98

#100: 21 35 45 78 A5 B2

It is also possible to add comments in the file by using two times the type «/» (slash)

```
// example file
#001: 05 A1 FF E4 // comment in the line
#005: 45 85 63 21 78 A5 B2
#100: 98 75 35 45 98 // my command
```

```
//other command
#064: 48 25 Ce 8b
```

```
#128: 4C 8E D9 5A //
#999: a4 Fc 48 3e 8B
// comments at the end of the file
```

An example to allow the triggering of the reading of the folder 001 of another MicroPlayer mkII.

```
#001: 80 01 01
```

Example of tag:

```
001[RS001]: Sending of the bytes of the line #001 of the file «serial.txt» on reading of the folder 001
002[RS064]: Sending of the bytes of the line #064 of the file «serial.txt» on reading of the folder 064
```

Note: If a folder is played in a loop, the RS232 message defined with the [RSxxx] tag will be send at each loop of the folder.

Example:

```
001[J001][RS099]: Playback the folder 001 in a loop. At each loop-back of the folder, the message described at line 099 of the file «serial.txt» will be send on the player's RS232.
```

● [WHL] - Play the folder during all the time that the corresponding inputs is activated

This tag allows you to play the contents of a folder as long as the corresponding input is activated. When the input associated with the folder is released, the player applies the output tags added to the folder name. As long as the corresponding input is activated, the folder is played in a loop.

Example:

```
001[WHL]: The folder 001 is played in a loop while the input 1 is activated. When the input 1 is released, the player STOP.
002[WHL][J045]: The folder 002 is played in a loop while the input 2 is activated. When the input 2 is released, the player plays the folder 045.
003[WHL][J999]: The folder 003 is played in a loop while the inputs 1+2 are activated. When the inputs 1+2 are released, the player plays the folder 999.
```

The player's dry contact inputs may be associated, it means that any changes in the mix of inputs will be managed at any time by the player.

Example:

```
000[J000]: The folder 000 is played in a loop when the player is powered on.
001[WHL][J000]: The folder 001 is played in a loop while the input 1 is activated. If the input 2 is activated in addition to the input 1, the player plays the folder 003.
002[WHL][J000]: The folder 002 is played in a loop while the input 2 is activated. If the input 1 is activated in addition to the input 2, the player plays the folder 003.
003[WHL][J000]: The folder 003 is played in a loop while the inputs 1+2 are activated. If the input 1 is released, the player plays the folder 002. But, if the input 2 is released, the player plays the folder 001.
```

● [NXTxxx] - Play a defined number of audio files from the folder.

This setting allows you to play a certain number of audio files from the folder designated by this tag. When the number of audio files played in the folder is reached, the player applies the output tags added to the folder name. If the number of files requested by the tag [NXTxxx] is greater than the number of audio files in the folder, the player will loop-back in the folder as needed in order to play the exact number of audio files requested.

With this tag, the player memorizes the audio files that are played. This means that the audio files already played by a previous command [NXTxxx] are not replayed if all audio files in the folder are not played.

The xxx parameter of the tag [NXTxxx] is the number of audio file to play in the designated folder. It is always written with 3 digits (example: 001, 045, 999). It is between 001 and 999.

Example:

001[NXT003]: 3 audio files are played in the folder 001, then the player STOP.

002[NXT001][J000]: 1 audio file is played in the folder 002, then the player plays the folder 000.

003[NXT005][RET]: 5 audio files are played in the folder 003, then the player plays the last folder called.

004[NXT001][SEQ][J000]: The next file is played in the folder 004 in sequential sort.

● [AUX] - Select the auxiliary input after reading the current folder

The EventPlayer mkII player has an AUXiliary audio input. On this input, it can be connected a sound source such as a satellite receiver, a computer, another audio player ...

The player is inserted in the main audio program to broadcast messages, news, music ...

The player can be used as a local program or as a backup system in the event of a failure of the main source.

Par programmation horaire ou déclenchement externe (contact d'entrée, Ethernet, liaison série...) le programme musical qui entre par la prise auxiliaire est coupé par un fondu de sortie et le contenu du répertoire sélectionné est diffusé. Si l'entrée Auxiliaire est à nouveau sélectionnée, le son remonte avec un fondu d'entrée.

Pour revenir du mode auxiliaire et lire un dossier, il faut lancer une action sur une des entrées, un programme horaire, un ordre sur la liaison RS232 ou par Ethernet.

By timestamped programming control or external trigger (input contact, Ethernet, serial link ...) the musical program that enters through the auxiliary jack is cut by a fade out and the contents of the selected folder is broadcast. If the Aux input is selected again, the sound rises with a fade in.

To return from the auxiliary mode and read a folder, it is necessary to launch an action on one of the inputs, scheduling command, a data on the RS-232 link or Ethernet.

Example :

001 [AUX] : Play folder 001 then select the Aux input

● Specific conduct:

- If a folder is missing but a command designates this folder, the playback is stopped.

-When triggering designating a folder that does not contain a file and if a name contains an optional tag, this option is executed. If no playback option (for example a jump)is indicated, the player turns into stop mode.

EP230 only

- **[Rxxx]** - Active or deactivate the outputs contacts when play folder

Each file can operate the different outputs directly without any additional programming. You can light lamps, operate motors or any other actions depending on the file play.

Attention, the state of the outputs can not evolve during the playing of the file. For this, you must use the Show Control function.

Example :

001[R001]	Active output 1 when play folder 001
002[R255]	Active the 8 outputs when play folder 002
004[R000]	Deactive all outputs when play folder 004

The values are between 000 and 255 following a binary progression. See the correspondence table in the annexes.

The outputs are switched at the beginning of the folder playback. If no other file has an option in its name, the outputs will not change and will not be disabled.

If an event file is played (Show Control function), the outputs may change depending on the scenario of the event file. We advise you to perform output switching in the Show Control scenario for more precise control of information.

4.2 Organisation of files inside folders.

Like for folders, files name define the playback conduct.

Note: The naming of the files is free if the reading is in a random mode. («RND» option or no option in the folder name). In this case, all the files will be read and can be interrupted.

In a sequential mode, you should number the files. The names are composed of 3 digits (001 to 999) and of a name of your choice. Optional informations (tags) can be added following your need, like the interruption of the file or the triggering of the outputs.

Example:

001 [J367] my message.mp3
063 [RS020] file name.wav
845 [V+12][RL01] my file.mp3»
MY SONG [NT].wav

Two types of audio files can be used:

- . WAV audio files (.wav).
- . MPEG layer 3 audio files (.mp3).

For more information on the audio file type supported by your player, please refer to the Annex B of this manual.

Note: In sequential mode (SEQ), if numbered and non-numbered files are present, only the numbered files will be read. In random mode, all the files be read.

- **The first three digits represent the file number as its principal name from 001 to 999.**

Example:

001.mp3 - file No.001
063.wav - file No.063

If the folder indicates random mode [RND], the files don't have to be numbered and playback will be in random mode. In sequential mode [SEQ], file are read in the first three digits order and the non-numbered files are ignored.

Optional parameters

To modify the conduct of the player, you can add optional parameters in the file name. These parameters are boxed by the symbols «[» and «]». You can use several parameters in the file name.

[Jxxx] - Jump to a folder after reading the current file.

[NT] - The file can not be interrupted or the action is memorised to be executed at the end of the file.

[RSxxx] – Sending of a sequence of bytes through RS232 link

[V+xx] or **[V-xx]** - Controls the volume level of the folder

EP230 only

[Rxxx] - Active ou désactive les différents contacts de sortie

Note: Without any option, the files are read the ones after the others according to the selected mode (random or sequential) and can be interrupted at any time by external action.

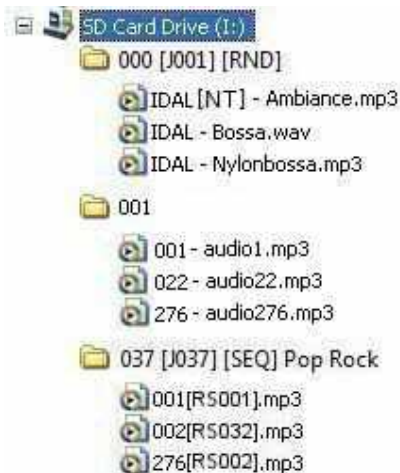

- **[Jxxx]** designates the folder number to use after reading the current file.

By adding this parameter within the file name, you define the conduct of the player at the end of the reading of the current file in order to read another file.

- If the destination folder does not exist, the playback is stopped.
- If the designating folder does not contain a file and if a name contains an optional tag, this option is executed. If no option is indicated, the player turns into stop mode.

Example:

My file [J002].mp3 - Jumps to folder 002 after reading file.

003 [J023][RL02].mp3 - Enable output 2 and jumps to folder 023 after reading file 003.

034 [J034].wav - Jumps to folder 034 after reading the file. It's not a loop with the file 034 but a jump to folder 034.

This function allows for example to survey a file in order that he is followed by a Jump. Several files can designate the same directory of jump.

Example :

001[J100].mp3 – After the reading of the file 001, Jump into folder 100

002[J100].wav – After the reading of the file 002, Jump into the folder 100

- **[NT]** - This option defines the interruption mode of the file currently read .

If this option is registered in the file name, the file cannot be interrupted and instructions received are ignored. **Without this option, reading of the current file can be interrupted at any time by an external action except if the option is included within the name of the file.**

Example:

001 [NT].mp3 - The file can NOT be interrupted.

An action on one of the input contacts, through RS232 link or any other is ignored and the reading of the current reading is not stopped. Caution! The action is not memorised and the triggering information is lost.

The files that can be interrupted and those that can not be interrupted can coexist in the same folder.

Note: the [NT] tag work exclusively on the change folder commands. The PLAY, STOP, NEXT FILE or PREVIOUS FILE commands are immediately executed.

- **[RSxxx]** – This tag allows to send bytes through RS232 output.

This tag allows to send bytes onto the RS232 output. When the file is called, a list of bytes is transferred by the serial link in order to control other devices (another player, switching grid, projector..) The bytes to send are included in a text file that will be especially created for that purpose.

Value by default : 19200 Bauds - 8 bits – no parity – 1 bit start – 1 bit stop
(modifiable through the config.txt file - see chapter 5)

The xxx parameter of the tag [RSxxx] is the number of serial command to send (number of the line in the «serial.txt» file). It is always written with 3 digits (example: 001, 045, 999). It is between 001 and 999.

The file definition of the bytes to send must be named : serial.txt

This file will be copied at the root of the media (SD memory card or USB flash drive)

ID-AL - EventPlayer mkII - Audio and DMX player - User manual

This file is a text file (raw text without page setting) that can be created with any easy text editor like «notepad» from windows or similar. On saving, use «ANSI» coding . Do not use special characters.

The file «serial.txt» of RS232 codes is a text file containing one or several lines. Each of these lines will include a sequence of bytes expressed in hexadecimal and separated by a space (from 00h to FFh). You must only indicate the two characters of the wished hexadecimal value.

Each beginning of line of this file should present the following parameter:

#xxx : xxx number of the line containing the bytes to send in connection with the xxx of the tag.

[RS002]-> The tag [RS002] will send the sequence of bytes of the line #002 of the «serial.txt» file.

The separator between each byte is a space.

Example of a line contained in the «serial.txt» file.

```
#001: 45 85 63 21 78 A5 B2
```

```
#002: 98 75 21 35 45 98
```

```
#100: 21 35 45 78 A5 B2
```

It is also possible to add comments within the file by using two times the type «/» (slash writer)

```
// example file
```

```
#001: 05 A1 FF E4 // comment in the line
```

```
#005: 45 85 63 21 78 A5 B2
```

```
#100: 98 75 35 45 98// my command
```

```
//other command
```

```
#064: 48 25 Ce 8b
```

```
#128: 4C 8E D9 5A //
```

```
#999: a4 Fc 48 3e 8B
```

```
// comments at the end of the file
```

An example to trigger the reading of the folder 001 of another MicroPlayer mkII.

```
#001: 80 01 01
```

Example of files:

```
001[RS001].mp3: Sending of the bytes of the line #001 of the «serial.txt» file on reading of the file 001
```

```
002[RS064].wav: Sending of the bytes of the line #064 of the «serial.txt» file on reading of the file 064
```

• [V+xx] or [V-xx] – file Volume setting

The name of the file can act on the output volume. This function is used to broadcast messages loud more or less than others files.

The increase or decrease of the volume by the volume tags is always done relatively the main volume.

The xx parameter of the tag [V+xx] and [V-xx] is the number of volume steps to increase or decrease the main volume. It is always written with 2 digits (example: 01, 32, 64). It is between 00 and 64.

Example:

```
001[V+05].mp3: increase the volume level from 5 steps during the file playback.
```

001[V-03].wav: decrease the volume level form 3 steps during the file playback.

At the end of the reading of the file, the volume level goes back to its previous level.

- If the variation values exceed the minimum or maximum values of the player, the levels are settled to their maximum or minimum.

EP230 only

● [Rxxx] - Active or deactivate the outputs contacts when play folder

Each file can operate the different outputs directly without any additional programming. You can light lamps, operate motors or any other actions depending on the file play.

Attention, the state of the outputs can not evolve during the playing of the file. For this, you must use the Show Control function.

Example :

001[R001] lion.mp3	Active output 1 when play the file
002[R255] cat.mp3	Active the 8 outputs when the file
004[R000] dog.wav	Deactive all outputs when the file

The values are between 000 and 255 following a binary progression. See the correspondence table in the annexes.

The outputs are switched at the beginning of the file playback. If no other file has an option in its name, the outputs will not change and will not be disabled.

If an event file is played (Show Control function), the outputs may change depending on the scenario of the event file. We advise you to perform output switching in the Show Control scenario for more precise control of information.

5 - Menu & configuration

Several settings are accessible through the Data button to configure the EventPlayer.

The DATA button has 2 functions:

- 1 - Endless rotation in both directions
- 2 - Validation push button

When the player is in normal mode (i.e. in a configuration menu), the rotation of the button allows adjustment of the volume level.

By pressing the button, you will be able to access the various set-up menus:

- 1 - Source selection (Player or Auxiliary)
- 2 - Bass & treble control of the player or the Auxiliary input
- 3 - Date & time setting
- 4 - Ethernet link parameters
- 5 - RS232 serial link parameters
- 6 - Miscellaneous options (Allocation of buttons, Fade in/out, Autoplay ...)
- 7 - Choice of display language



General usage of the button in the option menu:

- A rotation allows selection of a menu. Pressing confirms menu choice
- A rotation changes the value of the settings. Pressing confirms the selected setting and returns to the previous menu or moves to the next field.
- To exit the menu, turn the button until you see «Back» or «Exit» and confirm by pressing the button.

Reading the LCD display:

The menu name appears on the first line with below the associated parameter value.
To modify this value, press the button.

Volume control: Turn the DATA button to change the volume.

Caution! The volume can also be changed through the serial link, Ethernet and file name.

To change the player broadcast volume, select the main source «MAIN» in the «SOURCE» menu.
To change the Auxiliary input broadcast volume, select the «AUX» source in the «SOURCE» menu.

ID-AL - EventPlayer mkII - Audio and DMX player - User manual

First level menu choices:

SOURCE

MAIN

Selects either the player or the auxiliary in source
Displays the selected source (Main or Aux)



EQUALIZER MAIN

B 00 M 00 T 00

Controls the tone (in «AUX» mode, controls the tone of the AUX input)
Displays current values - B for Bass / M for Medium / T for Treble



DATE/TIME

01/01/2008 00:00

Sets time and date of the player
Displays current date and time of the player



ETHERNET

192 . 168 . 1 . 1

Sets the parameters of the Ethernet link
Displays the default IP address value of the player



RS-232 SERIAL

001 / 9600 / OFF

Sets the RS232 serial link parameters
Default value Player ID, link speed and operating mode



OPTIONS

Sets miscellaneous parameters such as allocation of buttons, fade in/out, amplifier control...



LANGUAGE

ENGLISH

Choice of display language
Default value



EXIT

Quits the option menu to go back to playback mode

Rotation = Menu choice

Click = Enter into the menu

6 - Show control and DMX link

The EventPlayer is not just an audio player, it can also read sequence files in order to operate DMX512 devices.

Using the Show Control Sequencer (free download from www.id-al.com) you will be able to create complete scenarios managing both broadcast of sound and sending commands to devices connected on the DMX port, in perfect synchronisation.

You are invited to refer to the software manual to use this function.

To this output you can connect any device compatible with the DMX512 protocol, such as dimmers, genlock projectors, DMX converters towards relays or servomotors.

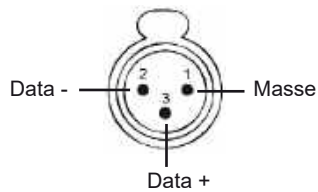

Principle of creating a project in Show Control software

The principle is to create DMX event tracks or output contacts and then place the events in a grid according to the timeline and the associated audio file.

Once the file has been created, simply copy it to the EventPlayer mkII media with the audio files. The operation of the player is the same whether it is an audio file, an event file alone or the synchro playback of both. Folders and their options, trigger input contacts and all other control devices such as time programming work the same way. Of course, you can use as many event files as you want.

Real time visualization - EP230 only

If you connect an USB cable from the player to a PC, you can then activate the real-time mode on the software. The reader becomes a PC to DMX interface. Playing your work on the software will display the result on the DMX output.

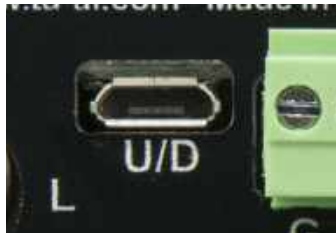

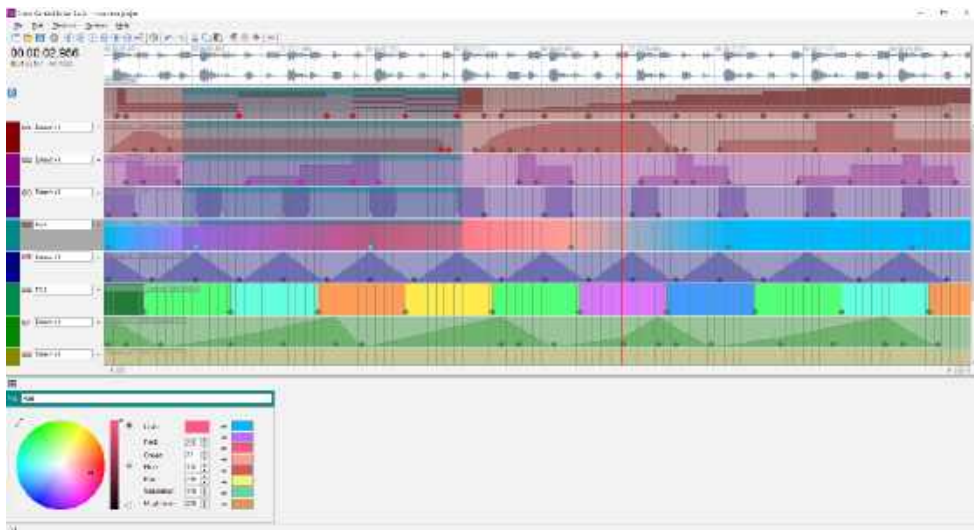

Creation phases in the software:

- 1 - Create a new project
- 2 - Open the audio file of the project to arrange it on the timeline.
- 3 - Display the DMX device patch and set the DMX channels used in the grid
- 4 - Place the different events in the tracks
- 5 - Save the file and transfer it to the media of the player (USB key, microSD).

Exporting the result file

When your Show Control file is finished, you must export the items to a file and transfer it to the drive media.

- In the «File» menu click on «Build show file». Export your project with the name of the audio file. You do not have to change the extension named «.sc2»
- Copy this file to the media used in the player in the same location as the associated audio file.

The name of the event file must have the same name as the audio file to be read at the same time and thus synchronized.

Example:

001

Lion.mp3

Lion.sc2

**The software and the complete manual are free to download
from the site www.id-al.com**

7 - Control with a Timestamped Programming (Scheduler)

7.1 Introduction

The EventPlayer mkII can be controlled thanks to a timestamped programming. This feature, named Scheduler, allows to timetable the playback of audio files (messages, spots, musics, sounds) and to stop or resume the playback on accurate date and time.

7.2 Principle

The EventPlayer mkII uses its built-in clock to perform scheduled actions. These actions are stored in a timestamped programming file named the Scheduler file.

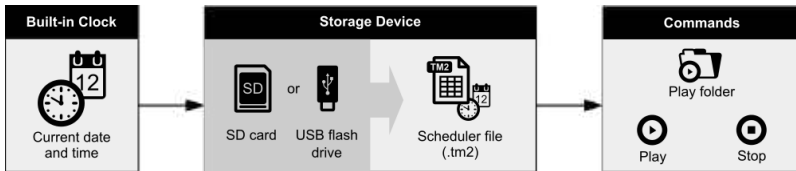

First, create a «Day template», (Monday, Saturday, Closed day, Special offer day...) where you will place the actions during the day (message, other folder, awake mode...). Then place the day template in the calendar and export the scheduler file to be copied on the media.

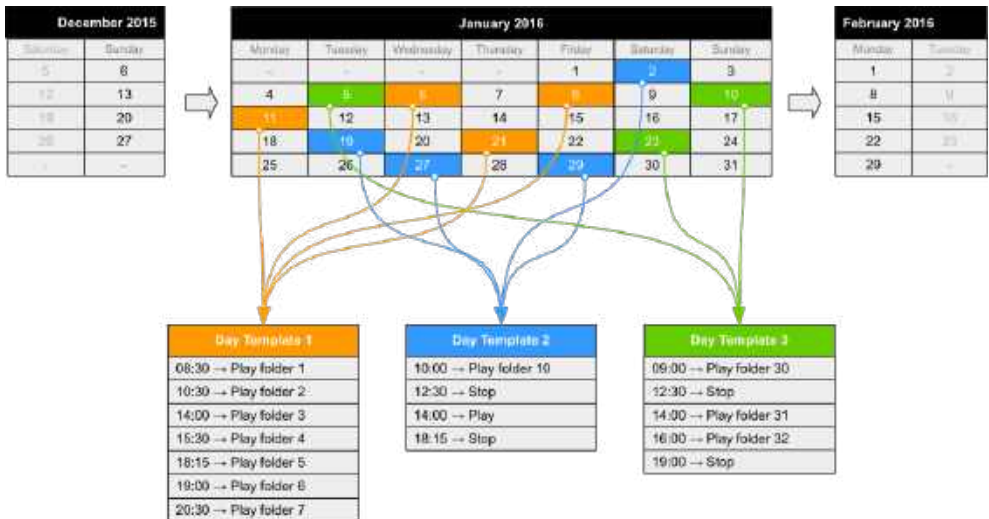

Notes :

- The dates requiring no actions are left empty and do not refer to any day template.
- If several dates require the exact same set of actions, then the calendar can refer to the same day template for these dates.

A day template contains all the events of a full day, for every minute, from 00:00 till 23:59. These events describe the command (action) to execute and when (precise time).

With the Scheduler feature:

- A schedule can contain up to 65535 different day templates.
- Within a day template, a different command can be scheduled for each minute.
- An action takes place precisely upon minute change.
- An event can execute a one-time command.

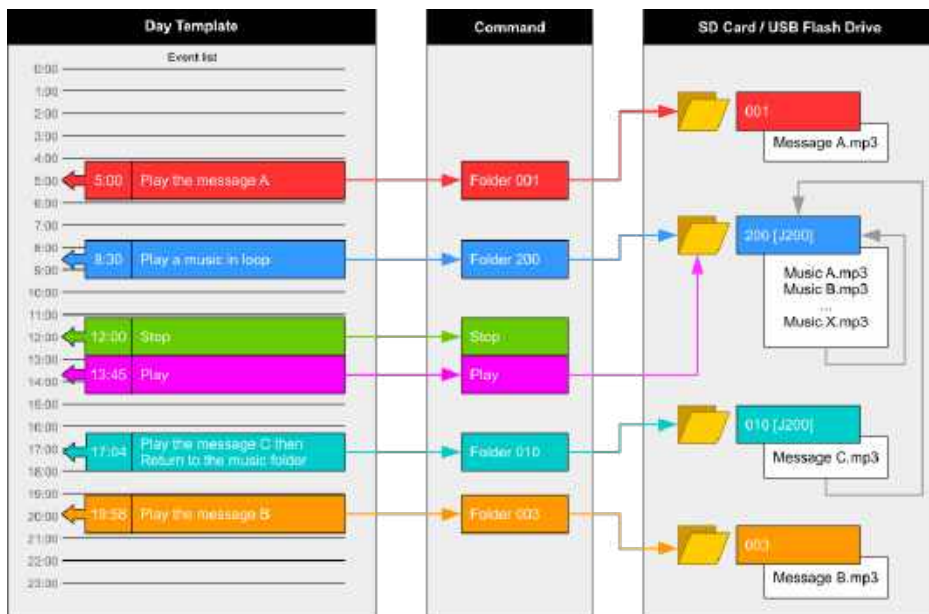

The following commands can be attached to an event:

PLAY FOLDER: launch the playback of a folder containing audio files (up to 1000 folders supported). This command requires the number of the folder to play (3 first digits between 000 and 999). The folder has to be stored in the root folder of the storage device. The way a folder is played depends on the tags appended to its name (loop: xxx[Jxxx], random: xxx[RND], sequential: xxx[SEQ]) (see the chapters Organization of the Folders).

PLAY: launch the playback of the folder in which the player stopped. If no folder playback action predates this command, or if the player stopped because out of a folder, this action is ignored.

STOP: stop the playback within the folder being played.

7.3 Creation of a Timestamped Programming File

The timestamped programming is stored in a Scheduler file. This file is generated by the Scheduler software developed for this purpose. Please check our website for additional information (www.id-al.com). The files generated by the Scheduler software are TM2 files with the .tm2 extension.

The file must be named: scheduler.tm2 and copied in the SYSTEM folder of the media.

**Scheduler software and complete manual could be downloaded
for free from the web site www.id-al.com**

8 - Auxiliary Input

By inserting the EventPlayer in an audio system, between audio source (computer, satellite receiver, multi CD player, tuner ...) and the amplification system, you will be able to trigger messages according to scheduled programming, action on input contacts or remotely via the internet.

The player acts as a message box to broadcast local information or adverts.

Switching of the auxiliary input is managed through the directory name (see related chapter). When a command is received to cut-off the auxiliary input in order to broadcast a message, the Auxiliary sound input fades out, down volume level 0. After broadcast of messages, a command to switch back to the auxiliary source is sent and volume level of the external source fades in from 0 to the maximum level. The Fade in/out time is adjustable in the Option menu.

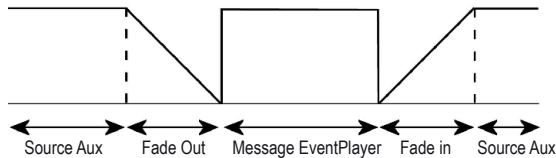

9 - RS-232 serial link protocol

The EventPlayer mkII can communicate with other devices by receiving instructions onto the Rx input or transferring data through its Tx output. The player complies with the RS-232 norm (see appendix for features).

Value by default: 19200 Bauds - 8 bits - no parity - 1 bit start - 1 bit stop
(modifiable through «config.txt» file)

9.1 - Reception Protocol

With the input protocol, the player can receive instructions to launch a folder playback or sets the volume. On the other hand, in a framework of the using of several players on the same link, the player answers its own number (defined in the file «config.txt», see chapter 5) or to a general command.

The reception protocol is made of a 3 bytes frame.

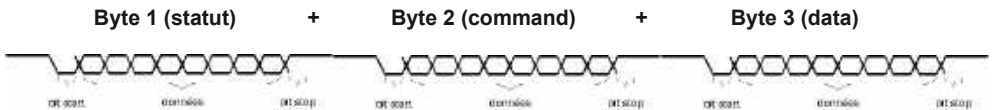

Reminder:

- a byte is composed of 8 bits: b7 b6 b5 b4 b3 b2 b1 b0
- a binary byte representation is noted: 1000000b or in hexadecimal : 80h

Byte 1 : Status - 1xxxxxxx

The byte status is a synchronization information of frame. Its bit 8 (b7) is always at 1. All others bits (commands or datas) have their bit 8 to 0.

b7 = 1: refer to a status bit

b6 - b0: identification of the player to be addressed from 001 to 127 (0000001b - 1111111b)

- The address of the player is by default (ID) 001. You can modify it in the config.txt file (see chapter 5)
- Several players may have the same identification number to create groups.
- Identification 000 is the «overall» address, all players are concerned by the command (unique command for all the players).

Example:

80h = «overall» address for all the players

81h = player n°001

9Eh = player n° 030

FFh = player n°127

Byte 2 (Command) 0xxxxxxx + Byte 3 (Data) 0xxxxxxx

The Byte 2 is a command and the byte3 is a data that completes the command byte. A command byte is always followed by a byte of data. A full frame is therefore made of 3 bytes.

b7 = 0 : refer to a byte of command or data

b6, b5, b4 : bank selection for the directory jump command

b3, b2, b1, b0 : command code sent to the player

List of commands:

00h: not used

X1h (01h to 71h): «Go to folder» command

02h: Player's transport command

03h: Volume command

● **00h - 00000000b: not used**

● **01h to 71h - 0xxx0001b : command of a jump into a folder**

The folder is designated by the bank number and the following data byte.

xxx is the bank number. In order to be able to launch 1000 folders (from 000 to 999), it is necessary to divide this number into several folder ranges (banks) of 128 values.

0xxx0001b: xxx = bank number depending on the folder number

01h - 00000001b : Bank 0 -> from 000 to 127

11h - 00010001b : Bank 1 -> from 128 to 255

21h - 00100001b : Bank 2 -> from 256 to 383

31h - 00110001b : Bank 3 -> from 384 to 511

41h - 01000001b : Bank 4 -> from 512 to 639

51h - 01010001b : Bank 5 -> from 640 to 767

61h - 01100001b : Bank 6 -> from 768 to 895

71h - 01110001b : Bank 7 -> from 896 to 999 (other value over 999 are ignored)

Method of calculation:

Bank = value in the above table depending on the folder number.

Value = folder number - (bank number x 128).

Example of a frame launching the folder 278 for the player number 001:

Folder number = 278

278 is in bank 2 (from 256 to 383).

Value = 278 - (2 x 128) = 22 = 16h.

For this example, the complete hexadecimal frame is: 81h 21h 16h.

● **02h - 00000010b: Transport bar command**

The transport function is defined by the data byte as follows:

Value of the datas of the byte 3 (data)

01h - 00000001b: Playback

02h - 00000010b: Stop

03h - 00000011b: Next file in the current directory

04h - 00000100b: Previous file in the current directory

05h - 00001001b : Not used

06h - 00001010b : Next folder

07h - 00001011b : Previous folder

Note: the other values are ignored.

Example of the full frame: 81 02 01

Octet 1 : 81h - 10000001b : status byte, player 001

Octet 2 : 02h - 00000001b : player's transport command

Octet 3 : 01h - 00000001b : playback command

● 03h - 00000011b : Volume control command

The value of the volume is defined by the datas byte as follows:

00h - 00000000b : mute - volume at 0

10h - 00010000b : half volume - value 50

1Fh - 00011111b : maximum volume - value 100

Note : the others values are ignored

Example of the full frame : 81 03 0E

Byte1 : 81h - 10000001b : status byte, plater number 001

Byte2 : 03h - 00000011b : volume command

Byte3 : 0Eh - 00001110b : volume setting at 14

9.2 - Transmission Protocol - Monitoring

The EventPlayer mkIII can send several kind of data onto RS-232 port.

- Personalised data sent by tags [RSxxx] (see chapter «naming of files and folders»)
- Command datas of the player sent in «Daisy Chain» mode
- Status data of the player sent in mode «monitoring» and «advanced monitoring»

To define the kind of sent datas through RS232, 4 monitoring modes exist.

The monitoring mode is defined in the LCD menu

The «Daisy Chain» mode and the monitoring mode are added up with the sending information mode through tags [RSxxx].

Mode 0: no monitoring mode

Only the data sent through tags [RSxxx] are sent to TX output.

Mode 1: «Daisy Chain»

In this mode, any information received on the Rx line is resent out as received onto the line Tx.

This mode allows to chain up several players the ones after to the others. By connecting Tx output of the first player to the Rx input of the second player and so on , the information received by the first player on its Rx socket is resent to the others players in chain. Caution ! if numerous players are connected in this way, a slight delay can exist on the end of the chain.

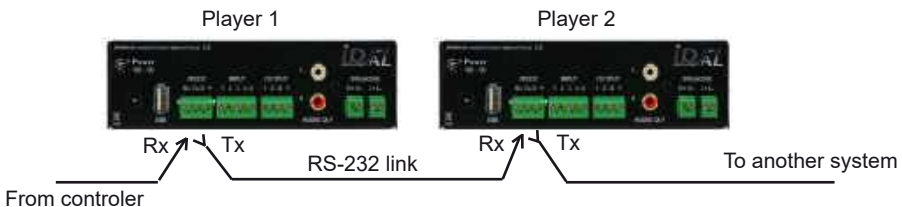

Mode 2: «Monitoring» mode

In this mode, the player send informations onto the Tx output depending on the actions executed. This mode do not allow to chain up the players. The player allows to a PLC, a computer, a security system, to know the status of the player and to make operating tests. In this mode, the player send data of its status upon each change.

The transmission protocol is made from a 3 bytes frame, similar to the reception protocol.

Byte 1: Status

>b7 = 1 : designates status byte

>b6 - b0 : designation of the sender player from 001 to 120 (0000001b - 1111111b)

The address (ID) of the player is by default 001 it has to say 81h. Modifiable in the config.txt file.

Byte 2 (Command)

Unique value : 00h - 00000000b

Byte 3 (Data)

00h - 00000000b : Player ready - The player reports that it is ready and available - when powering on, and operating.

01h - 00000001b : Not used

02h - 00000010b : Not used

03h - 00000011b : : Indicates the playback start - This code is sent when the player starts the playback

04h - 00000100b : Indicates end of playback - The player highlights it has finished the reading of the current file

Others values are not used.

Example of a process to check the good working of the player by reading an audio file.

Preparation: The player's number is 001

Create a folder «001» in which is copied an audio file»My file.mp3»

Launch folder 001 playback (with dry contact 1 trigger or with the sending of a command RS232).

When the player turns into playback, a frame is sent indicating the beginning of the playback:

81h 00h 03h

At the end of the playback, a frame is sent by the player indicating the end of the playback:

81h 00h 04h

Mode 3: «Advanced Monitoring» mode

The advanced mode have the same functions that the standard monitoring mode but adds a permanent sending function of its status. A frame is sent every 250ms describing the status of the player among two possibilities.

01h - 00000001b: sends a frame indicating that the player do not read and wait for an instruction.

02h - 00000010b: sends a frame indicating that the player reads a file.

This mode is used in a framework of security message management. A frame fault highlights an error and allows to solve the fault.

10 - Ethernet link

Via the Ethernet link, the EventPlayer communicates to update content via FTP (SD card, stick or USB HDD) and to receive commands in html Web server and check status of the player or outputs.

You can use the player in a local network. An adequately configured Modem/Router will allow remote control of the player via the Internet.

Caution! Network administration requires good computer skills.

In a local network installation, the player requires an IP address. This address is set in the Option menu (see option menu chapter). The player is then recognised on the network as a Web Server with «Internet Explorer» or «Firefox» browsers and as a FTP server with a FTP software such as Filezilla.

In an installation where only the player is present or in a local network with external access, you must use a Modem/Router to create a gateway between the player and the Internet.

Since the Modem/Router is configured with an IP gateway, you must declare this gateway to the EventPlayer so that it can communicate (configured in the Option menu).

Note: The EventPlayer does not offer DHCP mode.

10.1 - HTML Web server

Open your Web browser on your computer (for example Firefox) and enter the IP address of the player (the IP address is configured in the Option menu of the player). The home page should be displayed and you should be requested to enter your account and password.

Default value:

Account (user): idalweb

Password: idalweb

You will be able to modify account name and password in the configuration page.

Enter the requested information and validate to get access to the main page.



The page is composed of 4 parts:

A - Status of the player

This block displays the status of the player as well as the directory name and name of the file being read.

B - Status and operation of the output contacts

The cases indicates the current status of the output contacts. Simply click on the case that you wish to enable and click on «Validate».

C - Volume level control

The fields on the left indicate the current volume level of the player. To modify, select a value from the field and click «Validate»

D - Commands

You can control the player by clicking on the commands or entering a folder value.



The «config» menu allows setting of parameters of the player. You can modify the date and time as well as the various user accounts and passwords for Ethernet access.

Enter the information you wish to modify and click on «Validate».

If you have lost the account names and passwords, you must make a «Reset Factory» to initialise the player and revert to factory settings.

The «WEB access» parameters define the access modes to the html interface which is the one you see when you use a browser.

The «FTP access» parameters define the access modes to the FTP interface which you will use to update content of the memory cards or USB sticks. (See chapter below)

The last page «About us» displays ID-AL contacts.



10.2 - Use in FTP client

Via the Ethernet link, the VP3x0 communicates either to update content via FTP (microSD card, USB flash memory). You can use the player in a local network. An adequately configured Modem/Router will allow update the player via the Internet. In a local network installation, the player requires an IP address. This address is set in the LCD menu. The player is then recognized on the network as a FTP server with a FTP software such as «FileZilla».

When the player is connected in FTP mode, the player is in stop mode and can't play anything.

Demonstration purposes, we are using the freeware «FileZilla» but any other software may also be appropriate.

- Run «FileZilla»
- Enter the IP No. or the FTP address of the player
- Enter user name and password you have configured during installation

Host: IP adress User name and password is changed with the html access

User name: idalftp

Password: idalftp

Port: 21

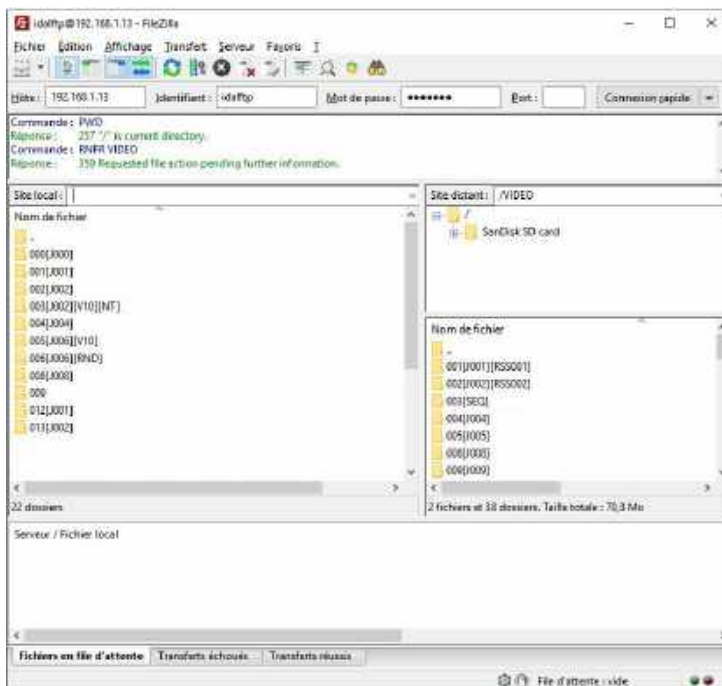

You are now connected to the media of the player and you have access to copy, delete, move, edit of file names as you would do locally.

Precautions for use:

- 1 - Prohibit multiple simultaneous transfers.
- 2 - Avoid using the passive mode. (if the function is available)

11 - Firmware Update

Logic and functionality of the player is defined by an internal program called «firmware». This program may evolve to provide new functionality, change the operation of the player or make corrections. The firmware can be updated or replaced by following these instructions:

The firmware upgrade is done from a microSD memory card (SD or SDHC). The upgrade is not supported from a USB flash memory.

- On the www.id-al.com web site, download the firmware from the support page of the EventPlayer mkII.
- Format your SD card in FAT32.
- Copy the file EVENT.bin at the root directory of the SD card.
- Eject the SD card by using the ejection process of your OS.
- Turn off the EventPlayer mkII.
- Put the microSD card in the player and switch on. Please, wait until the activity LED of the EventPlayer mkII turns green.
- At this time, the firmware update is finish. You can switch off the MicroPlayer mkII and remove the microSD Card.

12 - Reset factory

In some situations such as mistake, forgotten password, new installation, you may need to reinstall EventPlayer with the original settings. In this case, all configurations will be erased and you will have to set again the parameters of the LCD menu as if for a new device.

To carry out a reset factory and erase all the settings in order to restore them to the default values:

- 1 - The player must be switched-off
- 2 - Press the Volume/Menu button on the front panel and keep it pressed
- 3 - Switch on the player
- 4 - As soon as the message «factory reset» appears on the screen, release the button and wait
- 5 - When the reset process is completed, the usual welcome message is displayed
- 6 - Enter the Option menu to configure the elements you wish, like time and date.

Annexe A - Characteristics

Interfacing and Connectivity

- LCD display – 2 × 16 characters
- Clickable knob (volume and setting menu)
- Infrared sensor - Protocol: Sony SIRC, 12 bits, 38 kHz carrier
- DMX512 output on a standard female XLR3 connector
- microSD card slot
- USB Host 2.0 Full Speed (12Mb/s) type-A receptacle
- RS-232 serial link on a 3.81 mm pluggable terminal block (9600, 19200, or 38400 bauds)
- 10/100 Mbps Ethernet, RJ45 connector
- One opto-isolated input on a 3.81mm pluggable terminal block
- 2 power supply outputs dispatched on the pluggable terminal blocks
- 0 dBu unbalanced line-level stereo audio output on standard RCA
- 0 dBu unbalanced line-level stereo auxiliary audio input on a standard 3.5mm (TRS) jack
- Class D amplified speaker stereo audio output on 3.81mm pluggable terminal blocks
- External DC power supply chassis socket – Plug Ø 2.1mm / 5.5mm

EP230 only

- 8 opto-isolated inputs on a 3.81 mm pluggable terminal block
- 8 MOSFET outputs (500mA / output, max 20V) 3.81mm pluggable terminal block
- USB Device 2.0, Micro-B receptacle dedicated to the USB-to-DMX feature
- RJ9 connector to connect an external infrared sensor
- 5 V DC (500 mA) output on a pluggable terminal block

Audio File Formats Supported

- MP3 (.mp3): MPEG-1/2 Audio Layer III, mono/stereo, 16 bits, 44.1 / 48 kHz, from 32 kbit/s to 320 kbit/s, CBR (Constant Bit Rate) or VBR (Variable Bit Rate) files, with or without ID3v1/2 tags1
- Proprietary obfuscated MP3 (.mp3): to protect MP3 audio content
- WAV (.wav): mono/stereo, 16 bits LPCM, 44.1 / 48 / 96 kHz, WAVE_FORMAT_PCM or WAVE_FORMAT_EXTENSIBLE

Other File Formats Supported

- SC2 (.sc2): show control file - Show control V2 file format
- TM2 (.tm2): timestamped programming file (scheduler.tm2) - Scheduler V2 file format

Storage Devices

- Accepted storage device types: microSD/SDHC cards, USB flash drives
- File system supported: FAT32 (read/write)
- Supports long filenames limited to 63 characters maximum including extension

Network

- Embedded FTP server for remote content update
- Embedded SNTP client for clock synchronization with the network
- Static IP address (DHCP not supported)
- IPv4-compatible (IPv6 not supported)

Audio Amplifier

Speaker output:

- $2 \times 8 \text{ W} - 8 \Omega$, THD+N = 1 % , 1 kHz
- $2 \times 10 \text{ W} - 8 \Omega$, THD+N = 10 % , 1 kHz
- $2 \times 15 \text{ W} - 4 \Omega$, THD+N = 1 % , 1 kHz
- $2 \times 19 \text{ W} - 4 \Omega$, THD+N = 10 % , 1 kHz

Miscellaneous

- Player power supply input: 12V DC - 3A
- Timekeeping when the player is not powered: up to 2 months
- Operating ambient temperature: from 0 to +60 °C
- Storage temperature: from -20 to +60 °C

- Width: 143 mm - 1/3 of 19" rack
- Height: 44mm - 1U
- Depth (with terminal block): 208mm
- Weight: 543 g (with terminal block)

Accessories

- Rack support 19"- 1U
- Sensors and push buttons

Annexe B - Infrared remote control

An infrared sensor is fitted in the front of the EventPlayer to control the main functions.

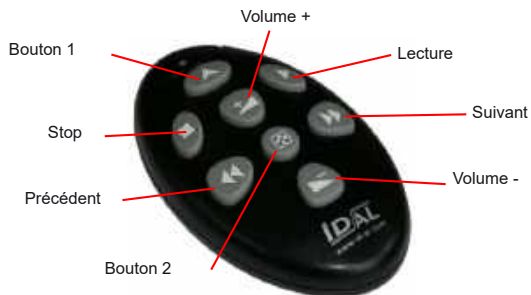

With this remote control you can:

Transport command: Play / Stop / Next / Previous

Volume command: Change volume up/down

Trigger key: Same function than buttons 1 and 2 in front of the player. (configurable button)



**Design and manufacturing of interactive
audio and video players**

**Check our products, informations
and technical solutions on our web site:
www.id-al.com**