



LB20 Premium Subwoofer

LB20-SW400-D | LB20-SW400-L



BOSCH

en Installation manual

Table of contents

1	Safety	4
1.1	Suspension	4
1.2	Notices	4
2	Short information	5
3	Introduction	6
3.1	System features	6
3.2	Packing list	7
3.3	Product information	8
4	Installation	9
4.1	Suspending the subwoofer	9
4.2	Replacing the logo	10
4.3	Installing the IP65 port covers	11
4.4	Installing the U-bracket - optional accessory	12
4.5	Installing the transformer input panel - optional accessory	13
4.6	Installing the crossover input panel - optional accessory	14
5	Wiring	15
5.1	Standard input panel	15
5.1.1	Mono operation	15
5.1.2	Stereo operation	16
5.2	Transformer input panel - optional accessory	17
5.2.1	Mono operation	17
5.2.2	Stereo operation	19
5.3	Crossover input panel - optional accessory	20
5.3.1	Mono operation	20
5.3.2	Stereo operation	21
6	Troubleshooting	23
7	Technical data	24
7.1	Dimensions	25
7.2	Frequency response and impedance	25
8	U-bracket dimensions - optional accessory	27

1 Safety

1.1 Suspension



Warning!

Suspending any object is potentially dangerous and should only be attempted by individuals who have thorough knowledge of the techniques and regulations of suspending objects overhead. Bosch strongly recommends all loudspeakers be suspended taking into account all current national, federal, state, and local laws and regulations. It is the responsibility of the installer to ensure all loudspeakers are safely installed in accordance with all such requirements. When loudspeakers are suspended, Bosch strongly recommends the system be inspected at least once per year or as laws and regulations require. If any sign of weakness or damage is detected, remedial action should be taken immediately. The user is responsible for making sure the wall, ceiling, or structure is capable of supporting all objects suspended overhead. Any hardware used to suspend a loudspeaker not associated with Bosch is the responsibility of others.

Safety point

As an added safety measure, it is suggested the user install an extra suspension point back to the building structural supports. This safety point should have as little slack as possible (less than 1-inch is preferable).

1.2

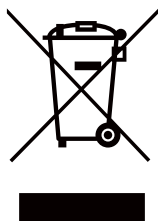

Notices

Old electrical and electronic appliances

Electrical or electronic devices that are no longer serviceable must be collected separately and sent for environmentally compatible recycling (in accordance with the European Waste Electrical and Electronic Equipment Directive).

To dispose of old electrical or electronic devices, you should use the return and collection systems put in place in the country concerned.

Copyright and disclaimer

All rights reserved. No part of this document may be reproduced or transmitted in any form by any means, electronic, mechanical, photocopying, recording, or otherwise, without the prior written permission of the publisher. For information on getting permission for reprints and excerpts, contact Bosch.

The content and illustrations are subject to change without prior notice.

2 Short information

The following table lists products in a family, with CTN (Commercial Type Number) and identifying product name DESCRIPTION.

CTN	Description
LB20-SW400-D	Cabinet subwoofer 2x10" black
LB20-SW400-L	Cabinet subwoofer 2x10" white
UB-10DB	U-bracket for 10" subwoofer black
UB-10DW	U-bracket for 10" subwoofer white
IP-10D-TB	Transformer input 10" subwoofer bk
IP-10D-TW	Transformer input 10" subwoofer wh
IP-10D-CB	Crossover input 10" subwoofer bk
IP-10D-CW	Crossover input 10" subwoofer wh

3 Introduction

The LB20-SW400 subwoofer, from Bosch, is a compact, high-performance, dual woofer loudspeaker with outstanding performance for the most demanding professional and commercial sound applications. Designed and engineered for use in background and foreground music, and sound reinforcement applications, the LB20-SW400 subwoofer is the ideal solution for indoor and outdoor applications, such as restaurants, bars, patios, retail, fitness clubs, hospitality, theme parks, leisure venues, and others. Ease of installation, and flexible options for mounting solutions and weather resistance, the LB20-SW400 subwoofer is the perfect solution for a wide variety of surface mount applications.

The LB20-SW400 subwoofer has been carefully engineered to resist outdoor environments, without compromising on performance for indoor applications. The subwoofer is IP54 rated, and its weather-proofing is complemented with exceptional cabinet and grille resistance against sun, salt and moisture. For the toughest weather conditions, the IP rating of the LB20-SW400 subwoofer can be upgraded to IP65, using the included port plug accessory.

Read through this manual to familiarize yourself with the safety information, features, and applications before you use these products.

3.1 System features

- Two 10 inch high-excursion woofers
- Carefully engineered for outdoor environments (IP54 and IP65), without compromising performance
- 400 W power handling provides for 120 dB maximum SPL (126 dB peak)
- 70/100 V transformer input panel accessory available
- Crossover input panel accessory available

3.2 Packing list

	Quantity	Component
A	1	Subwoofer
B	5	Mounting point covers
C	1	Logo (spare)
D	1	Allen wrench
E	1	Weather input cover
F	8	Screws for weather input cover
G	2	IP65 port covers
H	12	IP65 port cover screws
I	1	Installation manual

Table 3.1: Components list

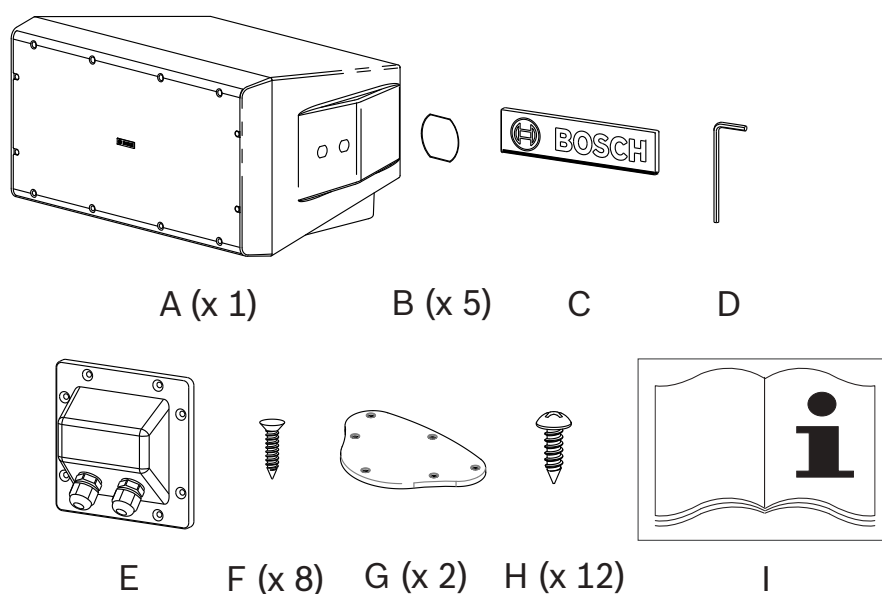

Figure 3.1: Components

3.3 Product information

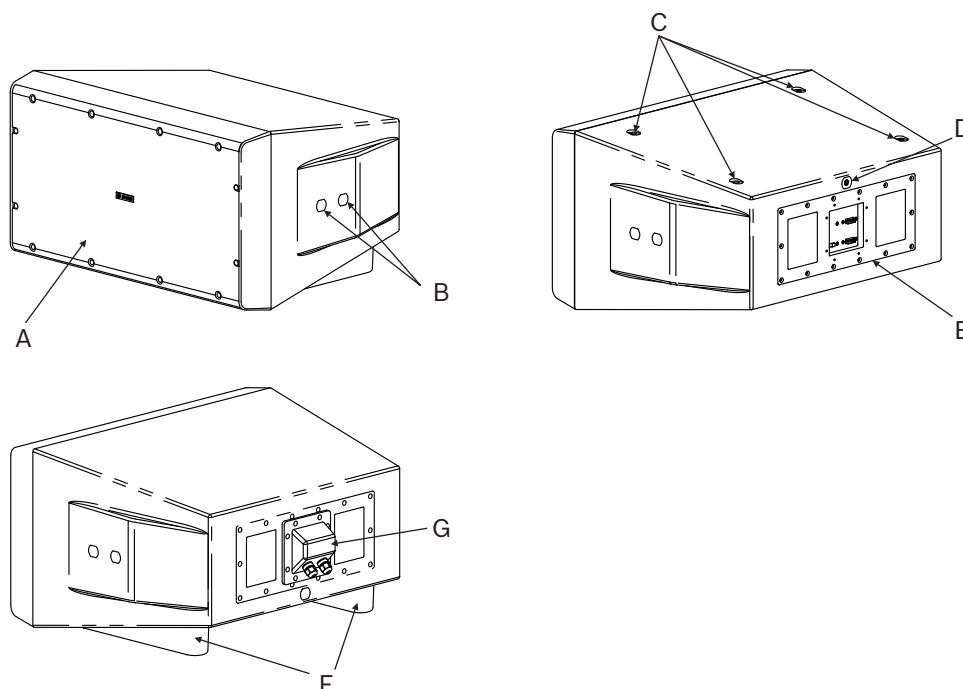

Figure 3.2: Product information (subwoofer on the right is shown upside down)

Item	Description
A	Grille
B	U-bracket mounting points
C	M8 flying points
D	M8 safety point
E	Input panel
F	Subwoofer feet
G	Weather input cover

Table 3.2: Product information

4 Installation

For safety, ensure the mounting surface supports more than the weight of the speaker. Use only industry-accepted fasteners and mounting methods when mounting the loudspeaker. Consult an expert if you are unsure.



Caution!

It is the installer's responsibility to determine and use the proper mounting hardware for the wall construction type.

Disregarding this caution could result in damage to the product and personal injuries may occur.

Safety point

As an added safety measure, it is suggested the user install an extra suspension point back to the building structural supports. This safety point should have as little slack as possible (less than 1-inch is preferable).

4.1 Suspending the subwoofer

To **suspend the subwoofer**, do the following:

1. Turn the **subwoofer** upside down.
2. Remove the two **subwoofer feet** with the supplied Allen wrench.

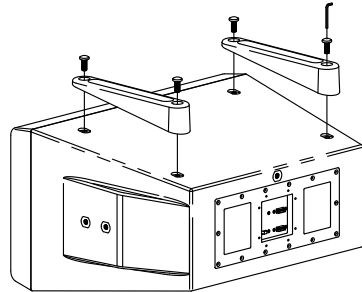

3. Attach the **mounting point covers** on the U-bracket mounting points.

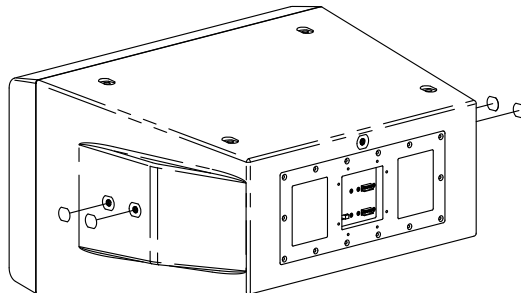

4. Rotate the **logo** by replacing it, as shown in the *Replacing the logo* section.

5. Install four **8-mm rated forged eyebolts** (not included) into the threaded fly points.

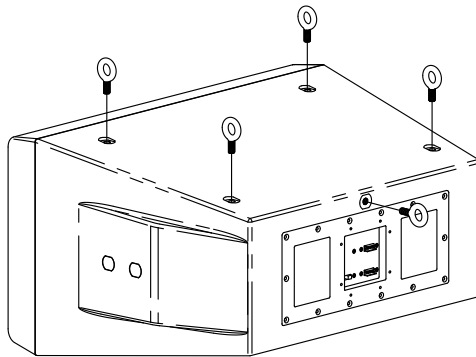

6. Install an **8-mm rated forged eyebolt** (not included) into the safety point.
7. Suspend the **subwoofer** from the eyebolts using rated fittings and steel cable.

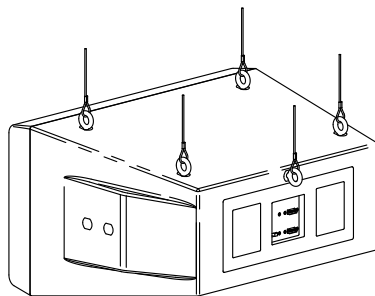

8. Secure the **subwoofer** from the safety eyebolt using rated fittings and steel cable.

See also

- *Replacing the logo, page 10*

4.2

Replacing the logo

An additional logo is included, vertical installation is shown.

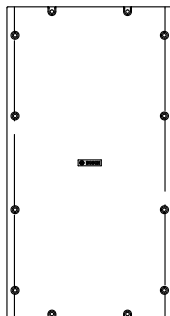

To **replace the logo**, do the following:

1. Remove the existing **logo**.
2. Clean the **surface** with alcohol.

- Align the square guide on the rear of the **logo** with the square guide on the grille.
This view is showing the grille and the logo from the rear.

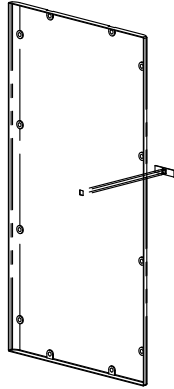

- Remove the **paper backing**.
- Insert the **logo**.
Press firmly to ensure the logo is applied.

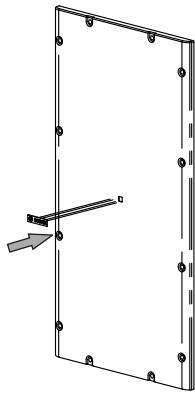

4.3 Installing the IP65 port covers

To **install the IP65 port covers**, do the following:



Caution!

Ensure you securely tighten the screws for the IP65 port cover to prevent water leaks.
If the IP65 port cover is not properly installed, you may cause damage to the subwoofer.

- Remove the **grille**.

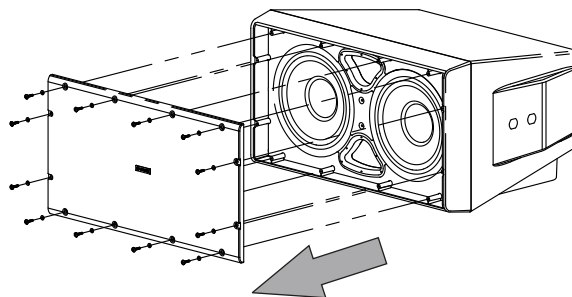

2. Install the **IP65 port cover**.
Repeat step this step to install the second IP65 port cover.

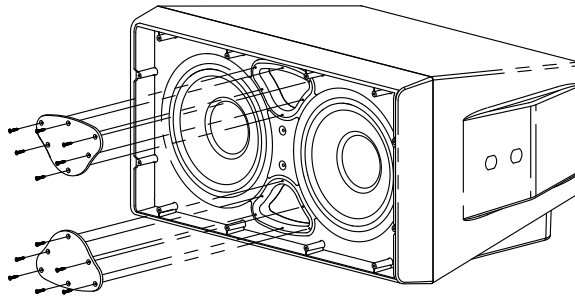

3. Reinstall the **grille**.

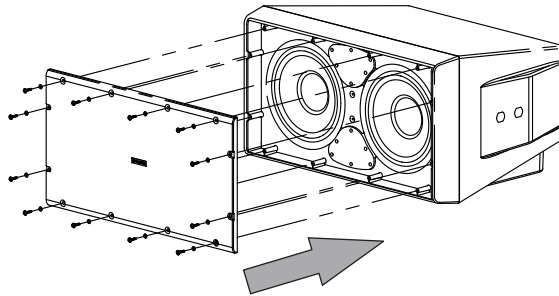

4.4

Installing the U-bracket - optional accessory

To **install the U-bracket**, do the following:

1. Install the **four screws** (provided) into the U-bracket mounting points.

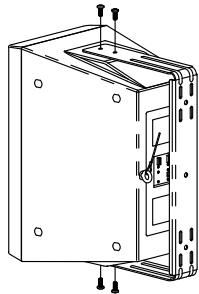

2. Install an **8-mm rated forged eyebolt** (not included) into the safety point.
3. Secure the **subwoofer** from the safety eyebolt using a rated fittings and steel cable.

Suspending the subwoofer in a down-fire position using the U-bracket

To **suspend the subwoofer in a horizontal down-fire position**, do the following:

1. Install **two 8-mm rated forged eyebolts using lock washers** (eyebolts and lock washers not included) into the fly points on the U-bracket.

